

PRODUCT DESCRIPTION

The profile is part of the system **MOD-KOZE-50**.

FINISH :

Non anodized (raw) 

*Custom colors available upon request



Fill empty fields

Product nr.	
Fixture type	
Company	
Job name	
Date	

TECHNICAL SPECIFICATION

AVAILABLE LENGTHS

Ref. nr.	surface finish	available lengths
18055NA_1	Non anodized (raw)	1000 mm
18055NA_2	Non anodized (raw)	2000 mm
18055NA_3	Non anodized (raw)	3000 mm

TECHNICAL DRAWING

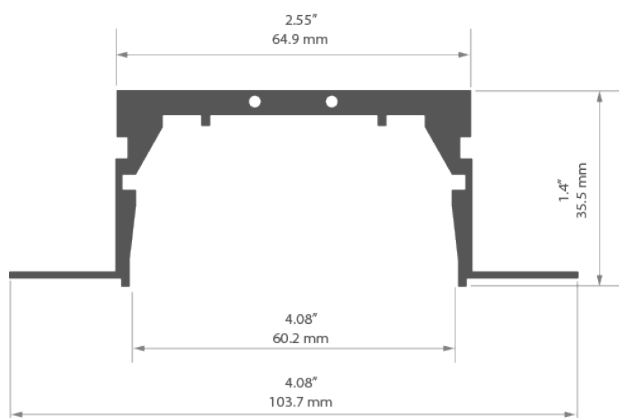

RELATED PROFILES



MOD-MOS-50
Profile
Ref: C1773

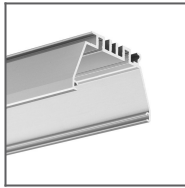

OMODO-50 Profile
Ref: 18053

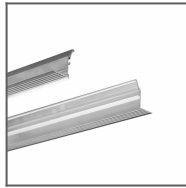

MOD-KR-KOZE
Profile
Ref: C1772

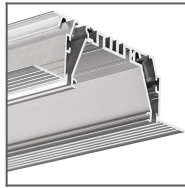

Profile system
MOD-KOZE-50
Ref: 18055 (RAM-
KOZE-50) +
18053
(OMODO-50)

RELATED PRODUCTS

END CAPS



RAM-TEZE-50
grey end cap
Ref: 24350

ACCESSORIES

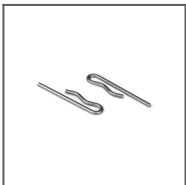

KR Spring
Ref: 42737



KR Tool
Ref: 70449

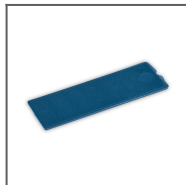

Mounting wedge
Ref: 70397

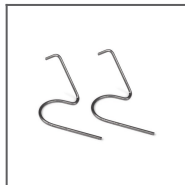

RAM-1 Spring
Ref: 42738



ZM-NA-135
Connector
Ref: 42725

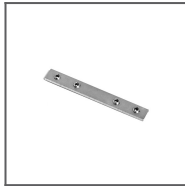

ZM-NA-180
Connector
Ref: 42724

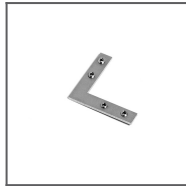

ZM-NA-90
Connector
Ref: 42723

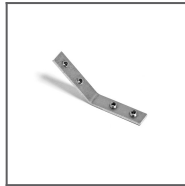

ZM-NA-PION-135
Connector
Ref: 42727



ZM-NA-PION-90
Connector
Ref: 42726