

PRODUCT DESCRIPTION

- Lighting direction of the fixture parallel to the surface
- The position can be corrected after screwing
- High mechanical and weather resistance

Fill empty fields

Product nr.

Fixture type

Company

Job name

Date



TECHNICAL SPECIFICATION

Application

- for mounting LED lighting fixtures

Mounting

- to the surface, using properly selected screws
- to the lighting fixture, with hooks
- easy installation and deinstallation of lighting fixtures by snapping in and out

TECHNICAL DRAWING

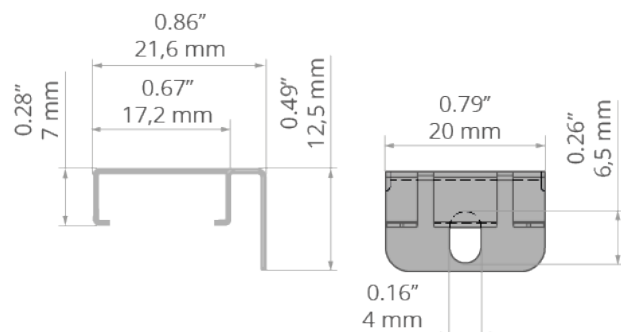

RELATED PROFILES



45-16 Profile
Ref: B8504

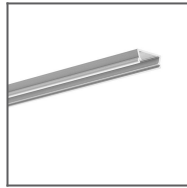

TAMI Profile
Ref: B5390

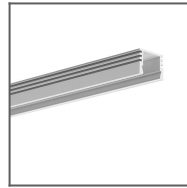

PDS-4-ALU Profile
Ref: B1718

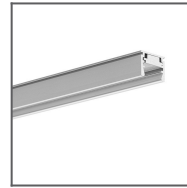

REGULOR Profile
Ref: B468+43

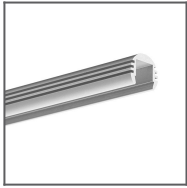

PDS-O Profile
Ref: B3777

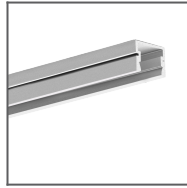

PDS-4-PLUS
Profile
Ref: C1263

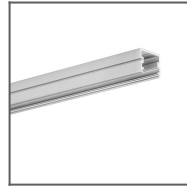

TAPO Profile
Ref: C1919

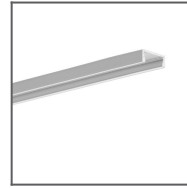

MICRO-PLUS
Profile
Ref: C2966

RELATED PRODUCTS

MARKETING MATERIALS



Display
P230-90276M
Ref: 90276M