

## PRODUCT DESCRIPTION

- Suitable for profiles with small sizes and smooth surface
- Suspends and powers the lighting fixture simultaneously

Fill empty fields

Product nr.

Fixture type

Company

Job name

Date



## TECHNICAL SPECIFICATION

### Application

- suspending and powering small-size lighting fixtures
- mounting to profiles without external elements for mounting accessories

### Assembly

- to the profile using the MR hook built into the fastener
- cable locked with a pressure screw

### Additional information

- suitable for conductive cables with a maximum diameter of 1.5 mm

## TECHNICAL DRAWING

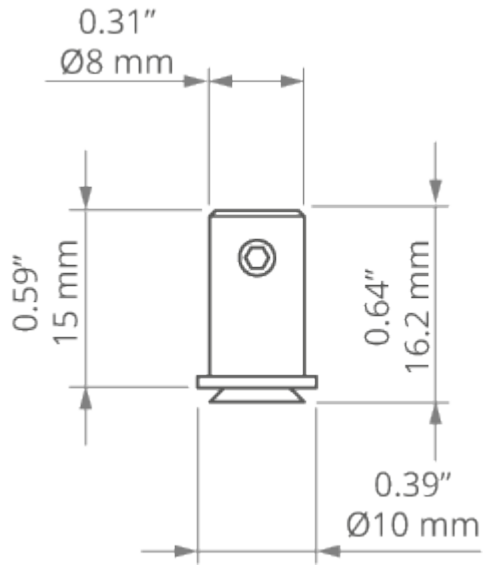

RELATED PROFILES

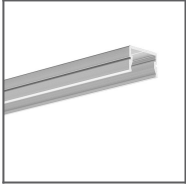

SILER Profile  
Ref: B9325

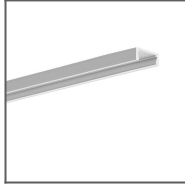

MICRO-ALU Profile  
Ref: B1888

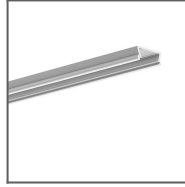

TAMI Profile  
Ref: B5390

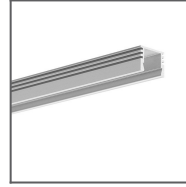

PDS-4-ALU Profile  
Ref: B1718



REGULOR Profile  
Ref: B468+43

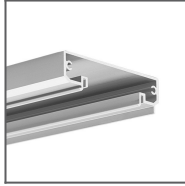

TESPO Profile  
Ref: 18020

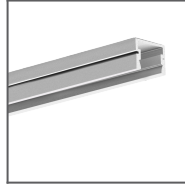

PDS-4-PLUS  
Profile  
Ref: C1263

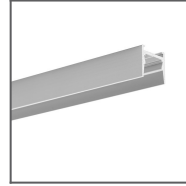

MICRO-HG Profile  
Ref: C1419

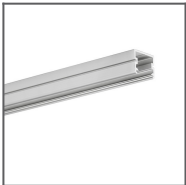

TAPO Profile  
Ref: C1919

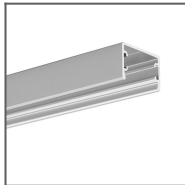

GLAZA-LL Profile  
Ref: C2627

## RELATED PRODUCTS

### ACCESSORIES



Isolated CU cable  
FI-1.35 mm  
Ref: 70310

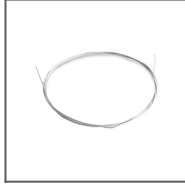

Steel wire FI-1 1m  
Ref: 1397