

PRODUCT DESCRIPTION

- Suitable for profiles with small sizes and smooth surface
- Suspends and powers the lighting fixture simultaneously

Fill empty fields

Product nr.

Fixture type

Company

Job name

Date



TECHNICAL SPECIFICATION

Application

- suspending and powering small-size lighting fixtures
- mounting to profiles without external elements for mounting accessories

Assembly

- to the profile using the MR hook built into the fastener
- cable locked with a pressure screw

Additional information

- suitable for conductive cables with a maximum diameter of 1.5 mm

TECHNICAL DRAWING

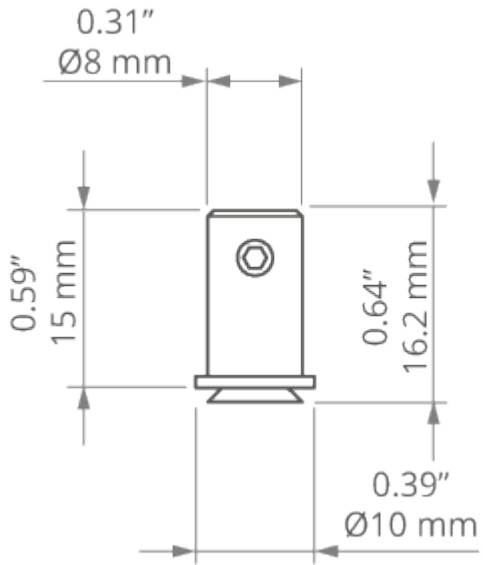

RELATED PROFILES

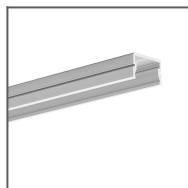

SILER Profile
Ref: B9325

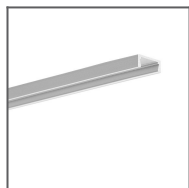

MICRO-ALU Profile
Ref: B1888

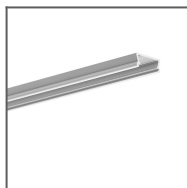

TAMI Profile
Ref: B5390

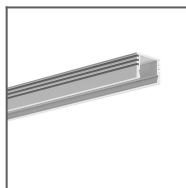

PDS-4-ALU Profile
Ref: B1718

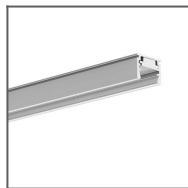

REGULOR Profile
Ref: B468+43

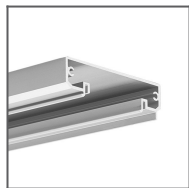

TESPO Profile
Ref: 18020

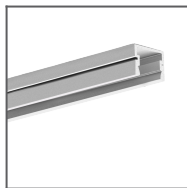

PDS-4-PLUS
Profile
Ref: C1263

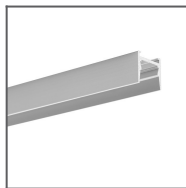

MICRO-HG Profile
Ref: C1419

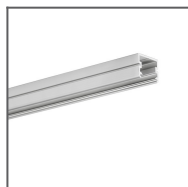

TAPO Profile
Ref: C1919

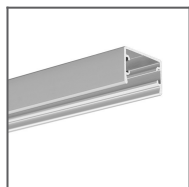

GLAZA-LL Profile
Ref: C2627

RELATED PRODUCTS

ACCESSORIES



Isolated CU cable
FI-1.35 mm
Ref: 70310

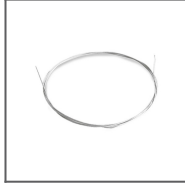

Steel wire FI-1 1m
Ref: 1397