

## PRODUCT DESCRIPTION

- Lengthwise suspension on a rod
- Fixing screw flush with the profile surface
- Minimum dimensions

Fill empty fields

Product nr.

Fixture type

Company

Job name

Date



## TECHNICAL SPECIFICATION

### Application

- for suspending LED lighting fixtures

### Mounting

- to the lighting fixture, using a small lock

- to the rod with a pressure screw

## TECHNICAL DRAWING

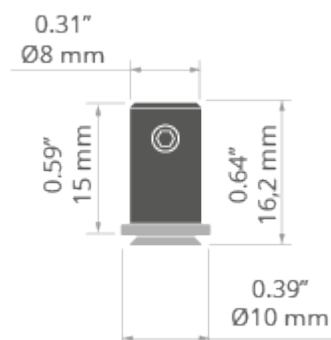

RELATED PROFILES

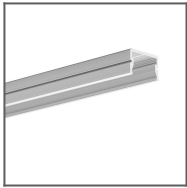

SILER Profile  
Ref: B9325

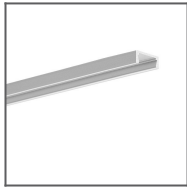

MICRO-ALU Profile  
Ref: B1888

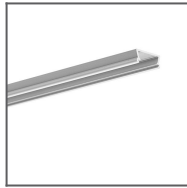

TAMI Profile  
Ref: B5390

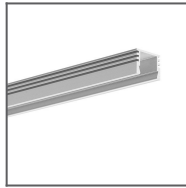

PDS-4-ALU Profile  
Ref: B1718



REGULOR Profile  
Ref: B468+43

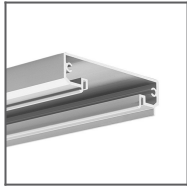

TESPO Profile  
Ref: 18020

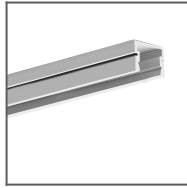

PDS-4-PLUS  
Profile  
Ref: C1263

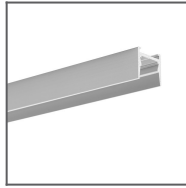

MICRO-HG Profile  
Ref: C1419

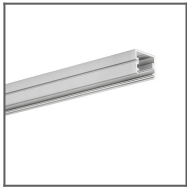

TAPO Profile  
Ref: C1919

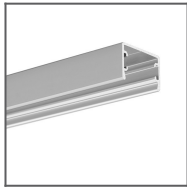

GLAZA-LL Profile  
Ref: C2627

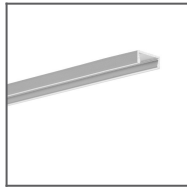

MICRO-PLUS  
Profile  
Ref: C2966

## RELATED PRODUCTS

## ACCESSORIES



FI-3-ALU Rod  
silver 1 m  
Ref: 42526



FI-3-ALU Rod  
silver 2 m  
Ref: 42528