





## PRODUCT DESCRIPTION

- Designed to reach an IP65 or IP67 waterproof rating
- For multiple applications
- Minimum dimensions for LED strips 10 mm wide
- Ability to obtain a line of light

### FINISH :

- Non anodized (raw) 
- Silver anodized 
- Black anodized 
- RAL  

\*Custom colors available upon request



Fill empty fields

Product nr.	
Fixture type	
Company	
Job name	
Date	

## TECHNICAL SPECIFICATION

### Application

- designed for the construction of lighting fixtures and backlighting luminaires. In furniture, exhibition, interior design elements like stair treads, platforms, shelves, niches, etc.
- can be embedded in narrow grooves
- can be used for external illumination in the sealed version, except for applications where it would be exposed to considerable mechanical forces

### Assembly

- can be mounted with appropriately selected mounting adhesives, professional double-sided adhesive tapes, metal and plastic mounting brackets, as well as adjustable mounting brackets. Also it can be mounted to drywall panels with the use of [PDS](#) mounting spring.

### Additional information

- possibility of making a linear fixture with IP65 protection, which means the fixture is dustproof and waterproof in contact with water jets
- possibility of making a linear fixture with IP67 protection, which means the fixture is dustproof and waterproof
- can be equipped with transparent and frosted covers, aluminum-colored plastic, metalized and conductive end caps
- spece for LED strip: 11.2 mm

**Profile bending with covers: HS, LIGER, KA.** Suitable for bending in the plane adjacent to the LED strip.

Minimum internal radius	Minimum external radius
150 mm	250 mm

- minimum radius – bending radius which when exceeded causes destruction (deformation, bending or lack of compatibility with other accessories, e.g. covers, end caps, etc.) of the profile
- internal radius – refers to the profile bent so that the cover is facing the inside of the arch
- external radius – refers to the profile bent so that the cover is facing the outside of the arch
- irregular curves are possible after consultation and individual quotation
- when bending anodized profiles, one should be aware of cracking of the anode coating (which may be more or less visible depending on the radius)

## AVAILABLE LENGTHS

Ref. nr.	surface finish	available lengths
B1718NA_1	Non anodized (raw)	1000 mm
B1718NA_2	Non anodized (raw)	2000 mm
B1718NA_3	Non anodized (raw)	3000 mm
B1718L9010NS_1	White RAL	1000 mm
B1718L9010NS_2	White RAL	2000 mm
B1718L9005NS_1	Black RAL	1000 mm
B1718L9005NS_2	Black RAL	2000 mm
B1718K7_1	Black anodized	1000 mm
B1718K7_2	Black anodized	2000 mm
B1718K7_3	Black anodized	3000 mm
B1718ANODA_1	Silver anodized	1000 mm
B1718ANODA_2	Silver anodized	2000 mm
B1718ANODA_3	Silver anodized	3000 mm

## TECHNICAL DRAWING

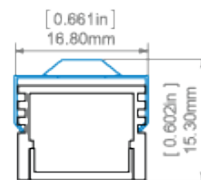
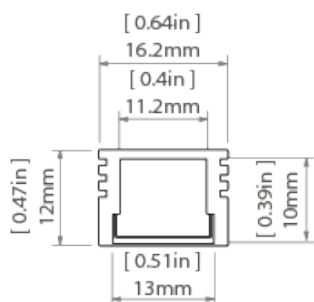

PDS-4-ALU profile and PDS-STN mounting bracket  
profil PDS-4-ALU z mocownikiem PDS-STN

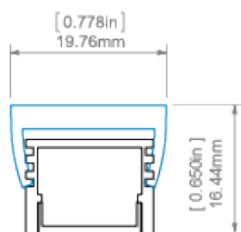

PDS-4-ALU profile and PL-PDM mounting bracket  
profil PDS-4-ALU z mocownikiem PL-PDM

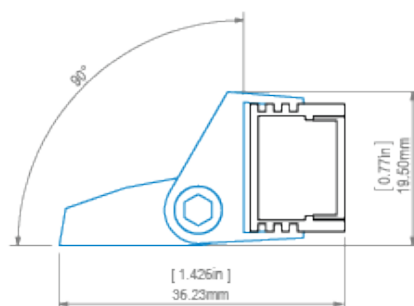

PDS-4-ALU profile and REG-PD-UV mounting bracket  
profil PDS-4-ALU z mocownikiem REG-PD-UV

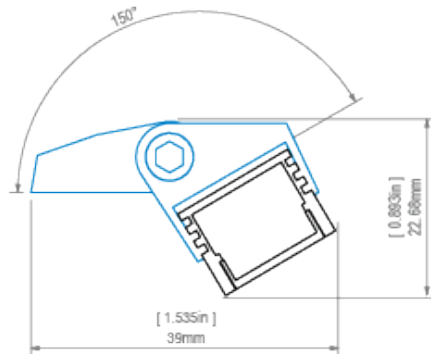

PDS-4-ALU profile and REG-PD-UV mounting bracket  
profil PDS-4-ALU z mocownikiem REG-PD-UV

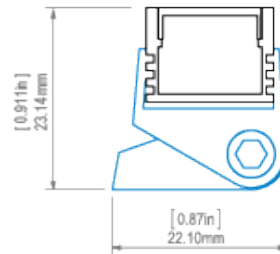

PDS-4-ALU profile and REG-PD-UV mounting bracket  
profil PDS-4-ALU z mocownikiem REG-PD-UV

**RELATED PRODUCTS**

**COVERS**

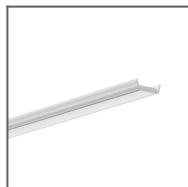

HS clear Cover  
Ref: 1370

50°



HS frosted Cover  
Ref: 1369

100°

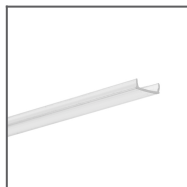

KA clear Cover  
Ref: 17036

60°

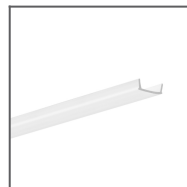

KA frosted Cover  
Ref: 17035

90°

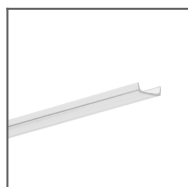

KA-COM clear Cover  
Ref: 17122

70°

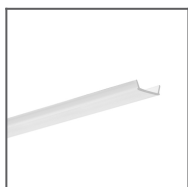

KA-COM frosted Cover  
Ref: 17121

100°

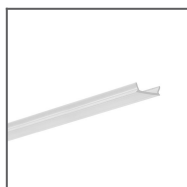

KA-PRO clear Cover  
Ref: 17065

50°

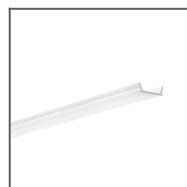

KA-PRO frosted Cover  
Ref: 17064

100°

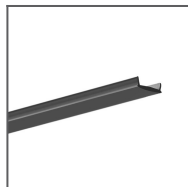

LIGER black Cover  
Ref: 17040

90°



LIGER frosted Cover  
Ref: 17037

120°



**END CAPS**



PDS-4-ALU black  
End cap  
Ref: 24066



PDS-4-ALU grey  
End cap  
Ref: 1056



PDS-4-ALU grey  
electricity  
conductive End  
cap  
Ref: 1407



PDS-4-ALU  
metalized End cap  
Ref: 24061

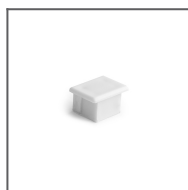

PDS-4-ALU white  
End cap  
Ref: 20002

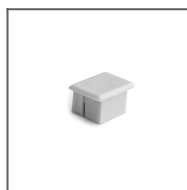

PDS-4-ALU-MW  
grey End cap  
Ref: 00026

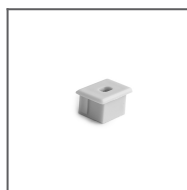

PDS-4-ALU-OTW  
grey End cap  
Ref: 1057



PDS-4-ALU-OTW-MW  
grey End cap  
Ref: 00027

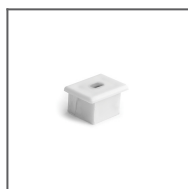

PDS-4-OTW white  
End cap  
Ref: 21002

## ACCESSORIES



6,4x1,6 Gland  
Ref: 00802L



6x1,2 Gland  
Ref: 00802



BZP Head  
Ref: 42213



BZP-ZO Head  
Ref: 42214



BZP-ZZ Head  
Ref: 42215



DP Fastener  
Ref: 00644

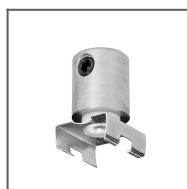

DP-MOC Fastener  
Ref: 00645



DP-MOC-ZO  
Fastener  
Ref: 00646

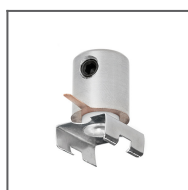

DP-MOC-ZZ  
Fastener  
Ref: 00647



DP-ZO Fastener  
Ref: 00649



DP-ZZ Fastener  
Ref: 00651



M11 Fastener set  
Ref: 42609



M12 Fastener set  
Ref: 42610

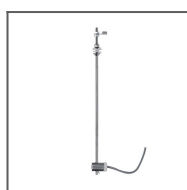

M13 Fastener set  
Ref: 42611



M14 Fastener set  
Ref: 42612



M3 Fastener set  
Ref: 42303



M4 Fastener set  
Ref: 42301



M5 Fastener set  
Ref: 42302

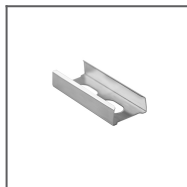

PD-MICRO  
Connector  
Ref: 42150

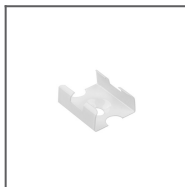

PDS Mounting  
bracket  
Ref: 24223



PDS Mounting  
bracket  
Ref: 24189

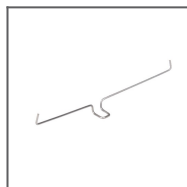

PDS Spring  
Ref: 00800



PDS-STN  
Mounting bracket  
Ref: 24190

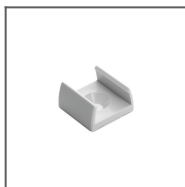

PL-PDM Mounting  
bracket  
Ref: 24041



PUSZ-LIN-MR  
Fastener  
Ref: 42258



PUSZ-PRET-MR  
Fastener  
Ref: 42252



REG-PD-UV  
Mounting bracket  
Ref: 24270



ST Head  
Ref: 42216



W1 Fastener set  
Ref: 42602



W10 Fastener set  
Ref: 42608



W2 Fastener set  
Ref: 42603



W6 Fastener set  
Ref: 42604



W7 Fastener set  
Ref: 42605



W9 Fastener set  
Ref: 42607



ZO Head  
Ref: 42217



ZZ Head  
Ref: 42218

## LED TAPES

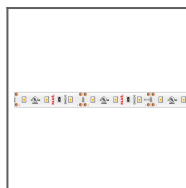

LED strip  
K-1210-12V 4.8  
W/m  
Ref: K-1210-12V

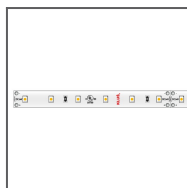

LED strip  
K-1210-24V  
4.8W/m  
Ref: K-1210-24V

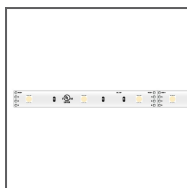

LED strip K-1215-  
RGB-12V 7.2W/m  
Ref: K-1215-RGB-12V

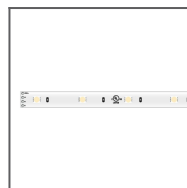

LED strip K-1215-  
RGB-24V 7.2W/m  
Ref: K-1215-RGB-24V



LED strip  
K-1220-12V 9.6W/m  
Ref: K-1220-12V

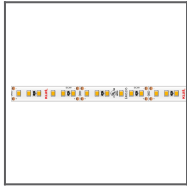

LED strip  
K-1220-24V  
9.6W/m  
Ref: K-1220-24V

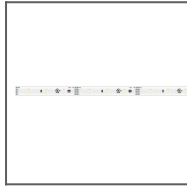

LED strip K-1225-  
RGB-12V 11.5W/m  
Ref: K-1225-RGB-12V

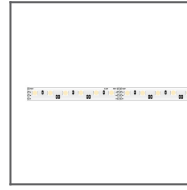

LED strip K-1225-  
RGB-24V 11.5W/m  
Ref: K-1225-RGB-24V

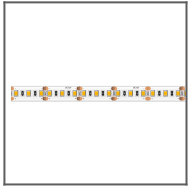

LED strip  
K-1275-12V  
14.4W/m  
Ref: K-1275-12V

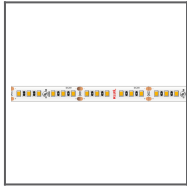

LED strip  
K-1275-24V  
14.4W/m  
Ref: K-1275-24V

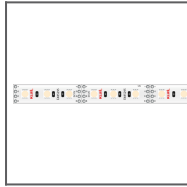

LED strip K-1275-  
RGB-12V 14.4W/m  
Ref: K-1275-RGB-12V

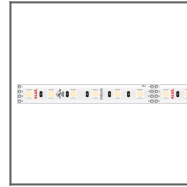

LED strip K-1275-  
RGB-24V 14.4W/m  
Ref: K-1275-RGB-24V

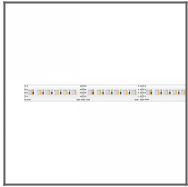

LED strip K-1530-  
RGB+W-24V  
Ref: K-1530-  
RGB+W-24V

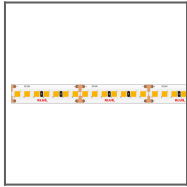

LED strip K-1820-  
HD-24V 18.2W/m  
Ref: K-1820-  
HD-24V

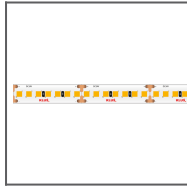

LED strip K-1910-HD-24V  
9.1W/m  
Ref: K-1910-HD-24V

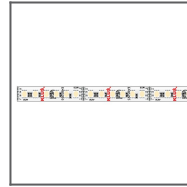

LED strip K-1920-120-  
RGB-24V 19.2W/m  
Ref: K-1920-120-  
RGB-24V

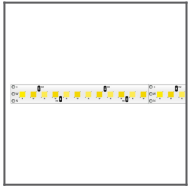

LED strip  
K-22/50-1728-24V  
17.28W/m  
Ref:  
K-22/50-1728-24V

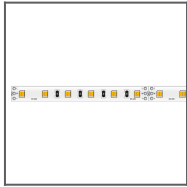

LED strip  
K-27/65-1920-24V  
19.2W/m  
Ref:  
K-27/65-1920-24V

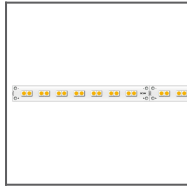

LED strip  
K-30/18-1770-24V  
11.5W/m  
Ref: K-30/18-1770-24V

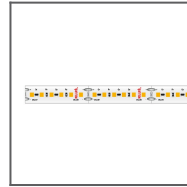

LED strip K-  
LR-1000-24V 10W/m  
Ref: K-LR-1000-24V

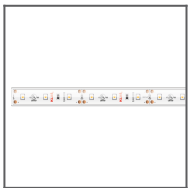

LED strip WP-  
K-1210-12V 4.8W/m  
Ref: WP-K-1210-12V



LED strip WP-  
K-1210-24V  
4.8W/m  
Ref: WP-  
K-1210-24V

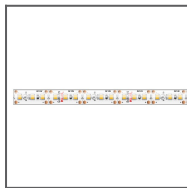

LED strip WP-K-1220-  
IP65-12V 9.6W/m  
Ref: WP-K-1220-  
IP65-12V

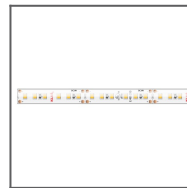

LED strip WP-K-1220-  
IP65-24V 9.6 W/m  
Ref: WP-K-1220-  
IP65-24V



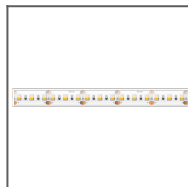

LED strip WP-K-1275-12V  
14.4W/m  
Ref: WP-K-1275-12V

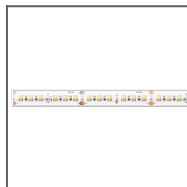

LED strip WP-K-1275-24V  
14.4W/m  
Ref: WP-K-1275-24V

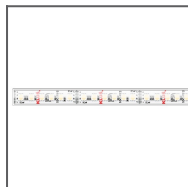

LED strip WP-K-1920-120-RGB-24V  
19.2W/m  
Ref: WP-K-1920-120-RGB-24V



LED strip WP-K-27/65-1920-24V  
19.2W/m  
Ref: WP-K-27/65-1920-24V

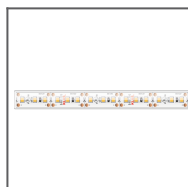

Taśma LED WP-K-1220-12V  
9.6W/m  
Ref: WP-K-1220-12V

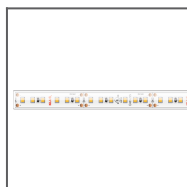

Taśma LED WP-K-1220-24V  
9.6W/m  
Ref: WP-K-1220-24V

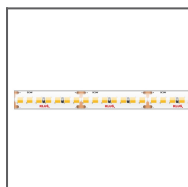

Taśma LED WP-K-1910-HD-IP65-24V  
9.1W/m  
Ref: WP-K-1910-HD-IP65-24V

## MARKETING MATERIALS



Display P230-90120M  
Ref: 90120M



Display P230-90154M  
Ref: 90154M



Presentation set 1  
Ref: 90051