

PRODUCT DESCRIPTION

- Designed to reach an IP67 waterproof rating
- Minimum dimensions for LED strips 10 mm wide
- Simple assembly
- Versatile application
- Low weight

FINISH :

Non anodized (raw) Silver anodized Black anodized RAL 

*Custom colors available upon request

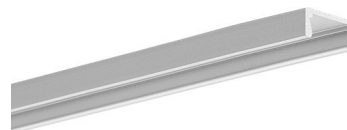

Fill empty fields

Product nr.

Fixture type

Company

Job name

Date

TECHNICAL SPECIFICATION

Application

- intended mainly for interiors, e.g. lighting of cabinets, stairs, display windows etc. With their small size, the lighting fixtures can be concealed in the walls of the furniture with small cross-sections
- in the sealed version, it can be used outdoors, for example on the facade of buildings, in the elements of garden architecture, in fencing elements, etc.

Assembly

- can be mounted with appropriately selected fixing glues, professional double-sided adhesive tapes, metal and plastic mounting brackets, as well as mounting brackets with angle adjustment, and by means of a mounting spring

Additional information

- possibility of making a linear fixture with IP67 protection, which means the fixture is dustproof and waterproof
- achieving IP67 is possible with the following covers: LIGER, KA, HS, KA-PRO and KA-COM
- can be equipped with transparent and frosted covers (diffusers), aluminum-colored plastic end caps, metalized and conductive end caps
- must not be used for diodes emitting high temperatures
- space for LED strip: 11.2 mm

Profile bending Suitable for bending in the plane adjacent to the LED strip.

Minimum internal radius	Minimum external radius
150 mm	150 mm

- minimum radius - bending radius which when exceeded causes destruction (deformation, bending or lack of compatibility with other accessories, e.g. covers, end caps, etc.) of the profile
- internal radius - refers to the profile bent so that the cover is facing the inside of the arch
- external radius - refers to the profile bent so that the cover is facing the outside of the arch
- irregular curves are possible after consultation and individual quotation
- when bending anodized profiles, one should be aware of cracking of the anode coating (which may be more or less visible depending on the radius)

AVAILABLE LENGTHS

Ref. nr.	surface finish	available lengths
B1888NA_1	Non anodized (raw)	1000 mm
B1888NA_2	Non anodized (raw)	2000 mm
B1888NA_3	Non anodized (raw)	3000 mm
B1888ANODA_1	Silver anodized	1000 mm
B1888ANODA_2	Silver anodized	2000 mm
B1888ANODA_3	Silver anodized	3000 mm
B1888K7_1	Black anodized	1000 mm
B1888K7_2	Black anodized	2000 mm
B1888L9010NS_1	White RAL	1000 mm
B1888L9010NS_2	White RAL	2000 mm
B1888L9005NS_1	Black RAL	1000 mm
B1888L9005NS_2	Black RAL	2000 mm

TECHNICAL DRAWING

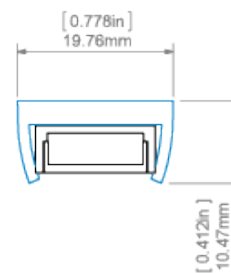
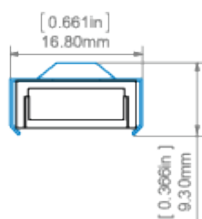
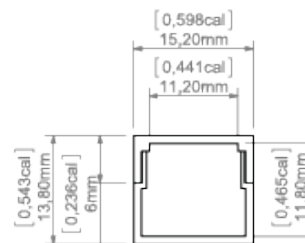
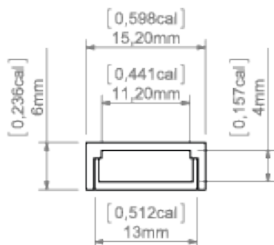

MICRO-ALU profile and PDS-STN mounting bracket
profil MICRO-ALU z mocownikiem PDS-STN

MICRO-ALU profile and PL-PDM mounting bracket
profil MICRO-ALU z mocownikiem PL-PDM

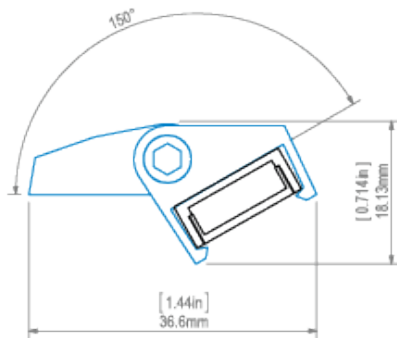

MICRO-ALU profile and REG-PD-UV mounting bracket
profil MICRO-ALU z mocownikiem REG-PD-UV

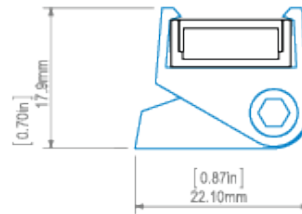

MICRO-ALU profile and REG-PD-UV mounting bracket
profil MICRO-ALU z mocownikiem REG-PD-UV

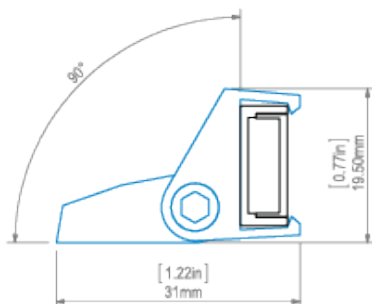

MICRO-ALU profile and REG-PD-UV mounting bracket
profil MICRO-ALU z mocownikiem REG-PD-UV

RELATED PRODUCTS

COVERS

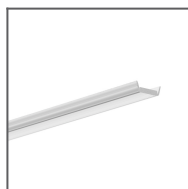

HS clear Cover
Ref: 1370

110°

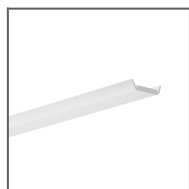

HS frosted Cover
Ref: 1369

110°

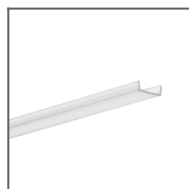

KA clear Cover
Ref: 17036

110°

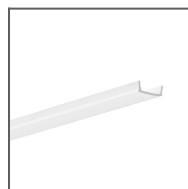

KA frosted Cover
Ref: 17035

110°

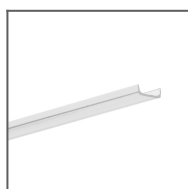

KA-COM clear Cover
Ref: 17122

100°

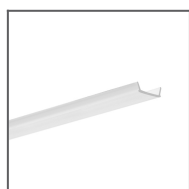

KA-COM frosted Cover
Ref: 17121

110°

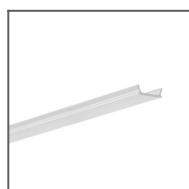
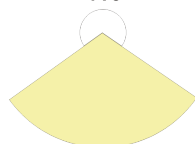

KA-PRO clear Cover
Ref: 17065

100°

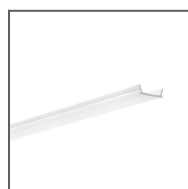

KA-PRO frosted Cover
Ref: 17064

100°

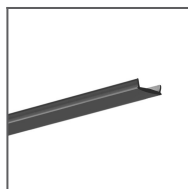

LIGER black Cover
Ref: 17040

90°

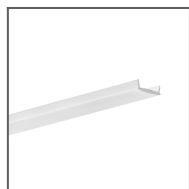

LIGER frosted Cover
Ref: 17037

120°

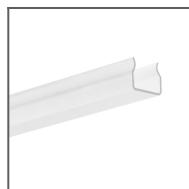

M-K frosted Cover
Ref: 17038

160°

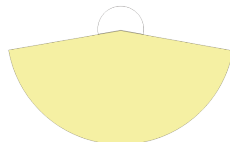

END CAPS



Electricity conductive MICRO
End cap
Ref: 1443



M-K grey End cap
Ref: 24216



MICRO-ALU black
End cap
Ref: 24068

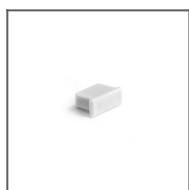

MICRO-ALU grey End
cap
Ref: 1058

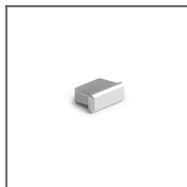

MICRO-ALU metalized End cap
Ref: 24062



MICRO-ALU white End cap
Ref: 20001



MICRO-ALU-OTW grey End cap
Ref: 1060



MICRO-ALU-OTW-MW grey End cap
Ref: 00024

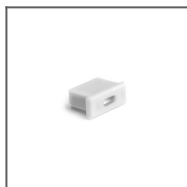

MICRO-ALU-OTW-MW white End cap
Ref: 23001



MICRO-M3 grey electricity conductive End cap
Ref: 42601

ACCESSORIES



6x1,2 Gland
Ref: 00802



BZP Head
Ref: 42213



BZP-ZO Head
Ref: 42214



BZP-ZZ Head
Ref: 42215



DP Fastener
Ref: 00644



DP-MOC Fastener
Ref: 00645



DP-MOC-ZO Fastener
Ref: 00646

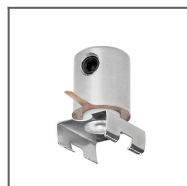

DP-MOC-ZZ Fastener
Ref: 00647



DP-ZO Fastener
Ref: 00649



DP-ZZ Fastener
Ref: 00651



M11 Fastener set
Ref: 42609



M12 Fastener set
Ref: 42610

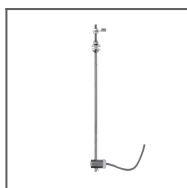

M13 Fastener set
Ref: 42611



M14 Fastener set
Ref: 42612



M3 Fastener set
Ref: 42303

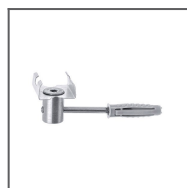

M4 Fastener set
Ref: 42301



M5 Fastener set
Ref: 42302

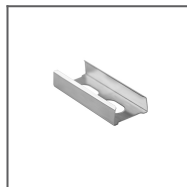

PD-MICRO
Connector
Ref: 42150

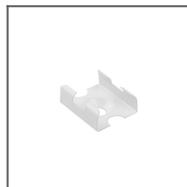

PDS Mounting
bracket
Ref: 24223

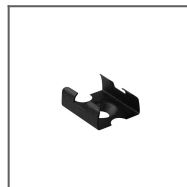

PDS Mounting
bracket
Ref: 24189

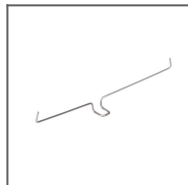

PDS Spring
Ref: 00800



PDS-STN
Mounting bracket
Ref: 24190



PIONISA Mounting
bracket
Ref: 24122

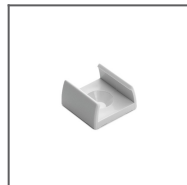

PL-PDM Mounting
bracket
Ref: 24041

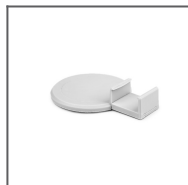

PLANISA
Mounting bracket
Ref: 24121



PUSZ-LIN-MR
Fastener
Ref: 42258



PUSZ-PRET-MR
Fastener
Ref: 42252



REG-PD-UV
Mounting bracket
Ref: 24270



ST Head
Ref: 42216



W1 Fastener set
Ref: 42602



W10 Fastener set
Ref: 42608



W2 Fastener set
Ref: 42603



W6 Fastener set
Ref: 42604



W7 Fastener set
Ref: 42605



W9 Fastener set
Ref: 42607



ZO Head
Ref: 42217



ZZ Head
Ref: 42218

LED TAPES

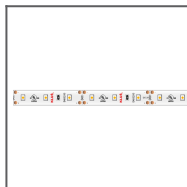

LED strip K-1210-12V
4.8 W/m
Ref: K-1210-12V

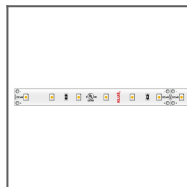

LED strip K-1210-24V
4.8W/m
Ref: K-1210-24V

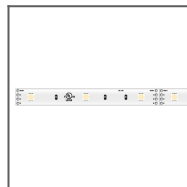

LED strip K-1215-RGB-12V 7.2W/m
Ref: K-1215-RGB-12V

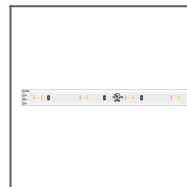

LED strip K-1215-RGB-24V 7.2W/m
Ref: K-1215-RGB-24V

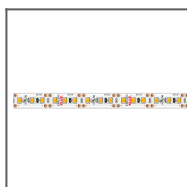

LED strip K-1220-12V
9.6W/m
Ref: K-1220-12V

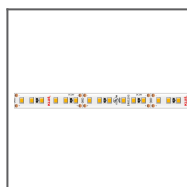

LED strip K-1220-24V
9.6W/m
Ref: K-1220-24V

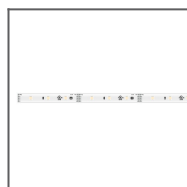

LED strip K-1225-RGB-12V 11.5W/m
Ref: K-1225-RGB-12V

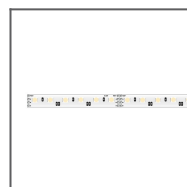

LED strip K-1225-RGB-24V 11.5W/m
Ref: K-1225-RGB-24V

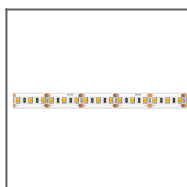

LED strip K-1275-12V
14.4W/m
Ref: K-1275-12V



LED strip K-1275-24V
14.4W/m
Ref: K-1275-24V

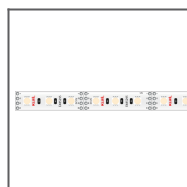

LED strip K-1275-RGB-12V 14.4W/m
Ref: K-1275-RGB-12V

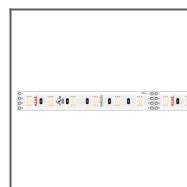

LED strip K-1275-RGB-24V 14.4W/m
Ref: K-1275-RGB-24V

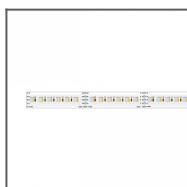

LED strip K-1530-RGB+W-24V
Ref: K-1530-RGB+W-24V

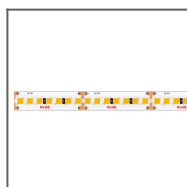

LED strip K-1820-HD-24V 18.2W/m
Ref: K-1820-HD-24V

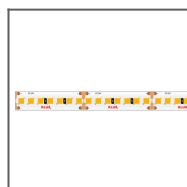

LED strip K-1910-HD-24V 9.1W/m
Ref: K-1910-HD-24V

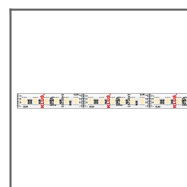

LED strip K-1920-120-RGB-24V 19.2W/m
Ref: K-1920-120-RGB-24V

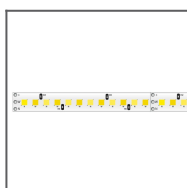

LED strip K-22/50-1728-24V
17.28W/m
Ref: K-22/50-1728-24V

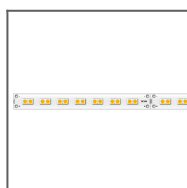

LED strip K-30/18-1770-24V
11.5W/m
Ref: K-30/18-1770-24V



LED strip K-LR-1000-24V 10W/m
Ref: K-LR-1000-24V



LED strip LED WP-K-1220-24V 9.6W/m
Ref: WP-K-1220-24V

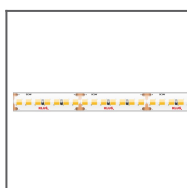

LED strip WP-1640-HD-IP65-24V 16.4W/m
Ref: WP-K-1640-HD-IP65-24V

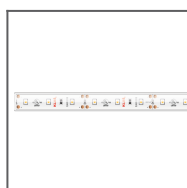

LED strip WP-K-1210-24V 4.8W/m
Ref: WP-K-1210-24V



LED strip WP-K-1210-12V 4.8W/m
Ref: WP-K-1210-12V

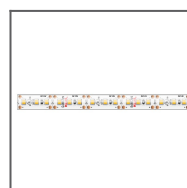

LED strip WP-K-1220-IP65-12V 9.6W/m
Ref: WP-K-1220-IP65-12V

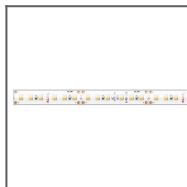

LED strip WP-K-1220-IP65-24V 9.6 W/m
Ref: WP-K-1220-IP65-24V

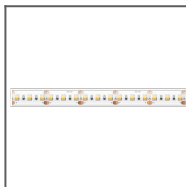

LED strip WP-K-1275-12V 14.4W/m
Ref: WP-K-1275-12V

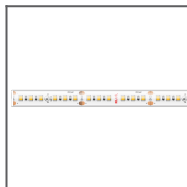

LED strip WP-K-1275-24V 14.4W/m
Ref: WP-K-1275-24V

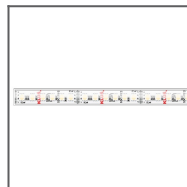

LED strip WP-K-1920-120-RGB-24V 19.2W/m
Ref: WP-K-1920-120-RGB-24V



LED strip WP-K-27/65-1920-24V 19.2W/m
Ref: WP-K-27/65-1920-24V

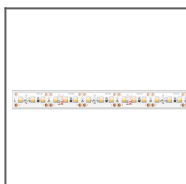

Taśma LED WP-K-1220-12V 9.6W/m
Ref: WP-K-1220-12V

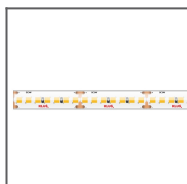

Taśma LED WP-K-1910-HD-IP65-24V 9.1W/m
Ref: WP-K-1910-HD-IP65-24V

MARKETING MATERIALS



Display P230-90083M
Ref: 90083M



Display P230-90120M
Ref: 90120M



Presentation set 1
Ref: 90051