

PRODUCT DESCRIPTION

- Designed to reach an IP67 waterproof rating
- Small size
- Resistant to standard loads expected for floors

FINISH :

Non anodized (raw) Silver anodized 

*Custom colors available upon request



Fill empty fields

Product nr.

Fixture type

Company

Job name

Date

TECHNICAL SPECIFICATION

Application

- waterproof, floor-mounted lighting fixtures in rooms briefly exposed to water (e.g. bathrooms)

Assembly

- glued into the prepared gap between floor tiles (or wall tiles)
- the remaining gap is filled with grout

Additional information

- possibility of making a linear fixture with IP67 protection, which means the fixture is dustproof and waterproof
- the profile withstands the standard load resulting from pedestrian traffic, typical of domestic rooms
- spece for LED strip: 11.2 mm

AVAILABLE LENGTHS

Ref. nr.	surface finish	available lengths
B1889NA_1	Non anodized (raw)	1000 mm
B1889NA_2	Non anodized (raw)	2000 mm
B1889NA_3	Non anodized (raw)	3000 mm
B1889ANODA_1	Silver anodized	1000 mm

Ref. nr.	surface finish	available lengths
B1889ANODA_2	Silver anodized	2000 mm
B1889ANODA_3	Silver anodized	3000 mm

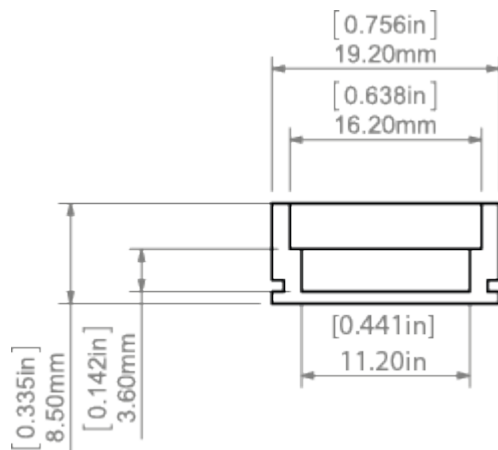
TECHNICAL DRAWING

RELATED PRODUCTS

COVERS

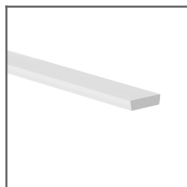

HR-ALU frosted Cover
Ref: 0945

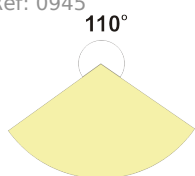

END CAPS

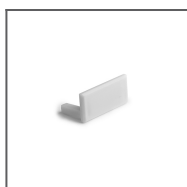

HR-ALU grey End
cap
Ref: 00010

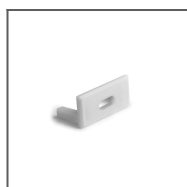

HR-ALU-OTW grey
End cap
Ref: 00347

ACCESSORIES



6x1,2 Gland
Ref: 00802

MARKETING MATERIALS



Presentation set 1
Ref: 90051

LED TAPES



LED strip LED WP-
K-1220-24V 9.6W/m
Ref: WP-K-1220-24V

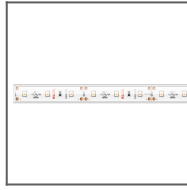

LED strip WP-
K-1210-12V 4.8W/m
Ref: WP-K-1210-12V

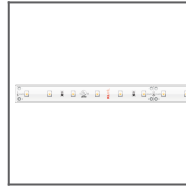

LED strip WP-
K-1210-24V
4.8W/m
Ref: WP-
K-1210-24V



LED strip WP-
K-1220-IP65-12V
9.6W/m
Ref: WP-K-1220-
IP65-12V



LED strip WP-
K-1220-IP65-24V 9.6
W/m
Ref: WP-K-1220-
IP65-24V

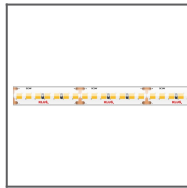

Taśma LED WP-K-1910-
HD-IP65-24V 9.1W/m
Ref: WP-K-1910-HD-
IP65-24V