

PRODUCT DESCRIPTION

- Designed to reach an IP67 waterproof rating
- Masks the edges of the groove
- Recessed shallow housing for LED strips up to 10 mm wide (0.39")

FINISH :

Silver anodized

*Custom colors available upon request



Fill empty fields

Product nr.

Fixture type

Company

Job name

Date

TECHNICAL SPECIFICATION

Application

- construction of lighting fixtures incorporated as furniture lighting

Assembly

- with mounting adhesive and professional double-sided adhesive tapes

Additional information

- possibility of making a linear fixture with IP67 protection, which means the fixture is dustproof and waterproof
- space for LED strip: 11.3 mm

Profile bending

Minimum internal radius	Minimum external radius
150 mm	150 mm

- minimum radius - bending radius which when exceeded causes destruction (deformation, bending or lack of compatibility with other accessories, e.g. covers, end caps, etc.) of the profile
- internal radius - refers to the profile bent so that the cover is facing the inside of the arch
- external radius - refers to the profile bent so that the cover is facing the outside of the arch
- irregular curves are possible after consultation and individual quotation
- when bending anodized profiles, one should be aware of cracking of the anode coating (which may be more or less visible depending on the radius)

AVAILABLE LENGTHS

Ref. nr.	surface finish	available lengths
B3775ANODA_1	Silver anodized	1000 mm
B3775ANODA_2	Silver anodized	2000 mm
B3775ANODA_3	Silver anodized	3000 mm

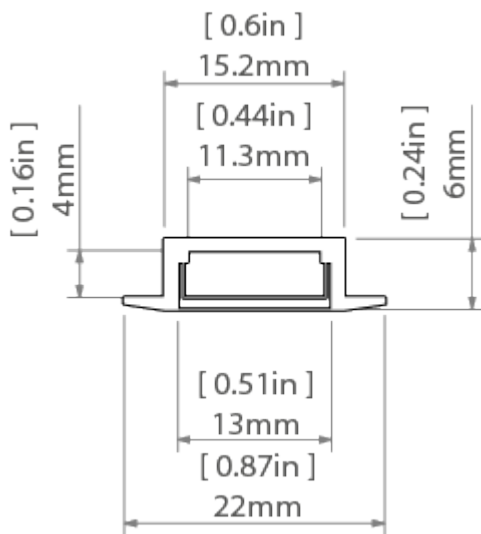
TECHNICAL DRAWING

RELATED PRODUCTS

COVERS

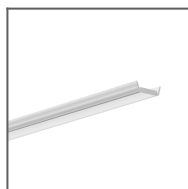

HS clear Cover
Ref: 1370

110°

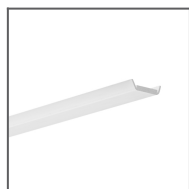

HS frosted Cover
Ref: 1369

110°

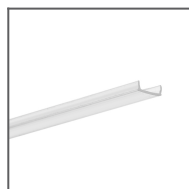

KA clear Cover
Ref: 17036

110°

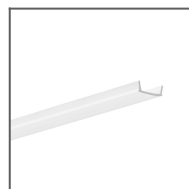

KA frosted Cover
Ref: 17035

110°

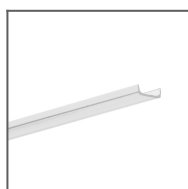

KA-COM clear Cover
Ref: 17122

100°

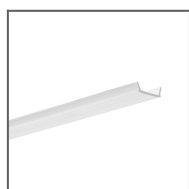

KA-COM frosted Cover
Ref: 17121

110°

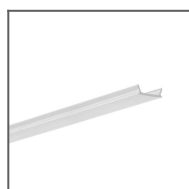

KA-PRO clear Cover
Ref: 17065

100°

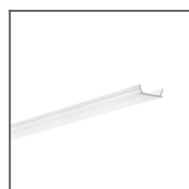

KA-PRO frosted Cover
Ref: 17064

110°

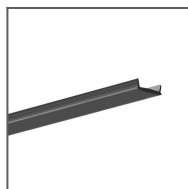

LIGER black Cover
Ref: 17040

90°

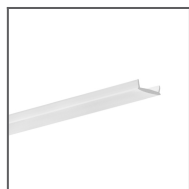

LIGER frosted Cover
Ref: 17037

120°



END CAPS

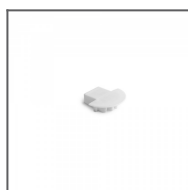

ECO-MICRO-K-OTW
End cap
Ref: 21004



MICRO-K grey End
cap
Ref: 1430



MICRO-K
metalized End
cap
Ref: 24060



MICRO-K white
End cap
Ref: 20004



MICRO-K-MW grey
End cap
Ref: 00025



MICRO-K-MW-OTW
white End cap
Ref: 23004



MICRO-K-OTW
grey End cap
Ref: 1448



MICRO-K-OTW-MW
grey End cap
Ref: 00308

ACCESSORIES



6x1,2 Gland
Ref: 00802

LED TAPES

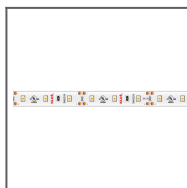

LED strip
K-1210-12V 4.8
W/m
Ref: K-1210-12V

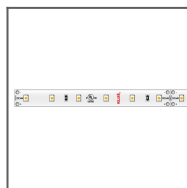

LED strip K-1210-24V
4.8W/m
Ref: K-1210-24V

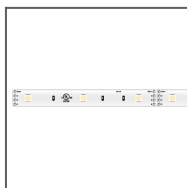

LED strip K-1215-
RGB-12V 7.2W/m
Ref: K-1215-RGB-12V

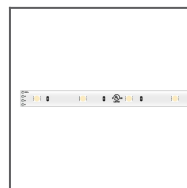

LED strip K-1215-
RGB-24V 7.2W/m
Ref: K-1215-RGB-24V



LED strip
K-1220-12V
9.6W/m
Ref: K-1220-12V

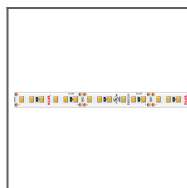

LED strip K-1220-24V
9.6W/m
Ref: K-1220-24V

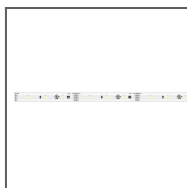

LED strip K-1225-
RGB-12V 11.5W/m
Ref: K-1225-RGB-12V

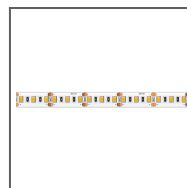

LED strip K-1275-12V
14.4W/m
Ref: K-1275-12V

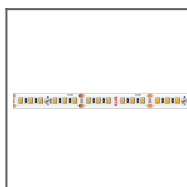

LED strip
K-1275-24V
14.4W/m
Ref: K-1275-24V

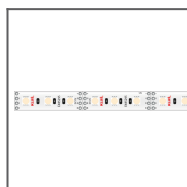

LED strip K-1275-
RGB-12V 14.4W/m
Ref: K-1275-RGB-12V

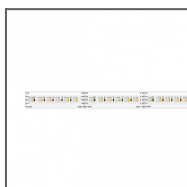

LED strip K-1530-
RGB+W-24V
Ref: K-1530-
RGB+W-24V



LED strip K-1820-
HD-24V 18.2W/m
Ref: K-1820-HD-24V



LED strip K-1910-HD-24V 9.1W/m
Ref: K-1910-HD-24V

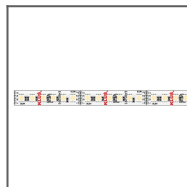

LED strip K-1920-120-RGB-24V 19.2W/m
Ref: K-1920-120-RGB-24V

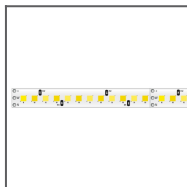

LED strip K-22/50-1728-24V 17.28W/m
Ref: K-22/50-1728-24V

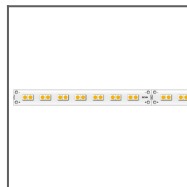

LED strip K-30/18-1770-24V 11.5W/m
Ref: K-30/18-1770-24V



LED strip K-LR-1000-24V 10W/m
Ref: K-LR-1000-24V

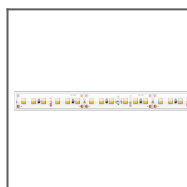

LED strip LED WP-K-1220-24V 9.6W/m
Ref: WP-K-1220-24V

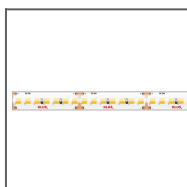

LED strip WP-1640-HD-IP65-24V 16.4W/m
Ref: WP-K-1640-HD-IP65-24V

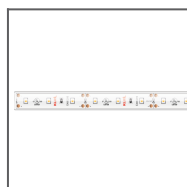

LED strip WP-K-1210-12V 4.8W/m
Ref: WP-K-1210-12V

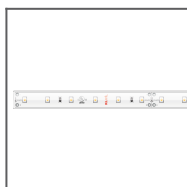

LED strip WP-K-1210-24V 4.8W/m
Ref: WP-K-1210-24V

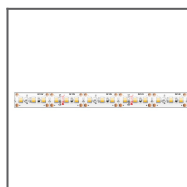

LED strip WP-K-1220-IP65-12V 9.6W/m
Ref: WP-K-1220-IP65-12V



LED strip WP-K-1220-IP65-24V 9.6 W/m
Ref: WP-K-1220-IP65-24V

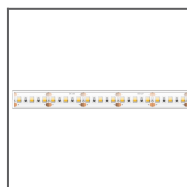

LED strip WP-K-1275-12V 14.4W/m
Ref: WP-K-1275-12V



LED strip WP-K-1275-24V 14.4W/m
Ref: WP-K-1275-24V

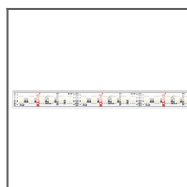

LED strip WP-K-1920-120-RGB-24V 19.2W/m
Ref: WP-K-1920-120-RGB-24V



Taśma LED WP-K-1220-12V 9.6W/m
Ref: WP-K-1220-12V

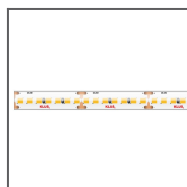

Taśma LED WP-K-1910-HD-IP65-24V 9.1W/m
Ref: WP-K-1910-HD-IP65-24V

MARKETING MATERIALS



Presentation set 1
Ref: 90051