

PRODUCT DESCRIPTION

- High luminous efficiency
- Ability to create a line of light
- Easy mounting with numerous methods
- Can be combined into straight and broken linear runs

FINISH :

Silver anodized

*Custom colors available upon request

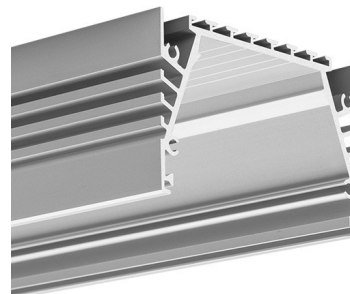

Fill empty fields

Product nr.

Fixture type

Company

Job name

Date

TECHNICAL SPECIFICATION

Application

- high performance, main lighting installation
- construction of surface mount or suspended lighting fixtures as main and work lighting (corridors, halls, workshops, ballrooms, etc.)

Assembly

- with surface springs, screws, various suspension systems or on a mounting strip

Additional information

- can be fitted with several different types of covers
- space for LED strip: 44 mm

AVAILABLE LENGTHS

Ref. nr.	surface finish	available lengths
B6593ANODA_1	Silver anodized	1000 mm
B6593ANODA_2	Silver anodized	2000 mm
B6593ANODA_3	Silver anodized	3000 mm

TECHNICAL DRAWING

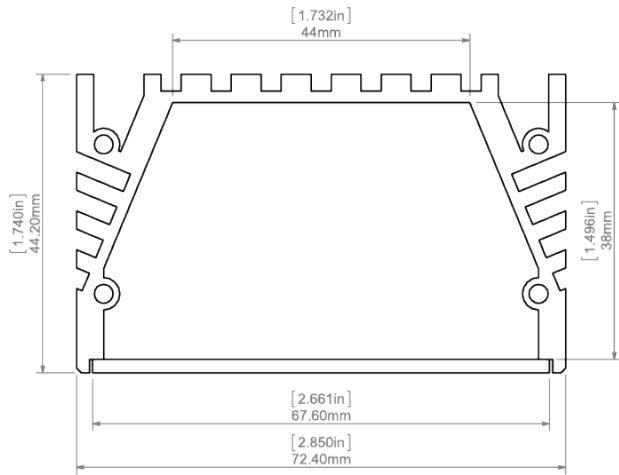

RELATED PROFILES

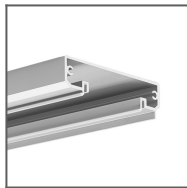

TESPO Profile
Ref: 18020

RELATED PRODUCTS

COVERS

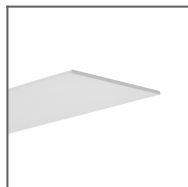

SZER clear Cover
Ref: 17082

80°

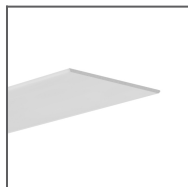

SZER frosted Cover
Ref: 17081

80°

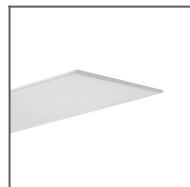

SZER-FALA
frosted Cover
Ref: 17085

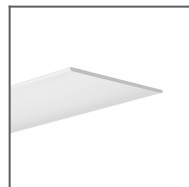

SZER-L frosted Cover
Ref: 17083

110°

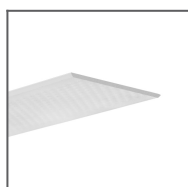

SZER-STRUKTURA
frosted Cover
Ref: 17084

END CAPS



SEPOD metalized
End cap
Ref: 24106

ACCESSORIES



FI-10-ZM-P
Fastener
Ref: 42244



FI-10-ZM-W
Fastener
Ref: 42242



Gland 6,4x3
Ref: 42264



PUSZ-LIN-ZM
Fastener
Ref: 42256



PUSZ-LIN-ZM
Fastener
Ref: 42275



PUSZ-LIN-ZM
black Fastener
Ref: 42275L9005



PUSZ-PRET-ZM
Fastener
Ref: 42250



PUSZ-PRET-ZM
Fastener
Ref: 42276



PUSZ-PRET-ZM
black Fastener
Ref: 42276L9005



RD-1 Fastener set
black
Ref: 42650



RD-1 Fastener set
silver
Ref: 42649



RG-1 Fastener set
black
Ref: 42648



RG-1 Fastener set
silver
Ref: 42647

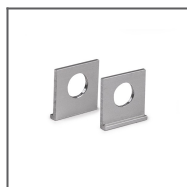

UCHO-ZM Hanger
Ref: 42512

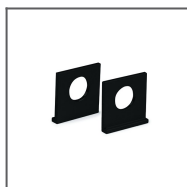

UCHO-ZM black
Hanger
Ref: 42525

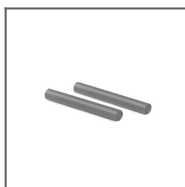

ZM Block
Ref: 42520

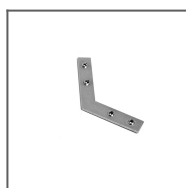

ZM-120
Connector
Ref: 42728

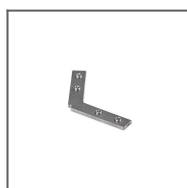

ZM-120-G
Connector
Ref: 42308

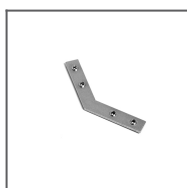

ZM-135
Connector
Ref: 42720

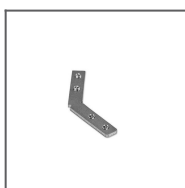

ZM-135-G
Connector
Ref: 42310

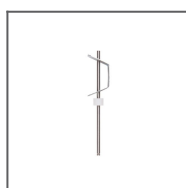

ZM-150 Fastener
Ref: 42118

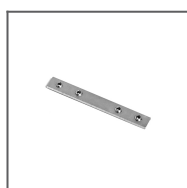

ZM-180
Connector
Ref: 42717

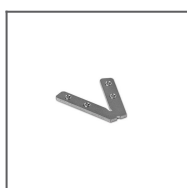

ZM-45-G
Connector
Ref: 42338

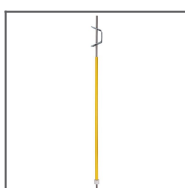

ZM-500 Fastener
Ref: 42119

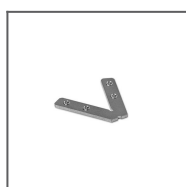

ZM-60-G
Connector
Ref: 42304

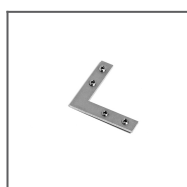

ZM-90 Connector
Ref: 42716

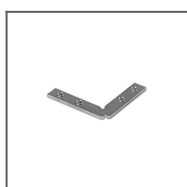

ZM-90-G
Connector
Ref: 42306

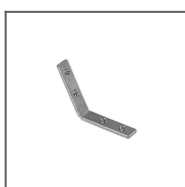

ZM-PION-120
Connector
Ref: 42320

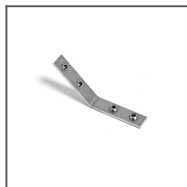

ZM-PION-135
Connector
Ref: 42719



ZM-PION-45
Connector
Ref: 42314



ZM-PION-90
Connector
Ref: 42718

MARKETING MATERIALS



Display
P230-90071M
Ref: 90071M



Presentation set 4
Ref: 90054