

## PRODUCT DESCRIPTION

- Combines several functions:
  - lighting fixture
  - frame for a stretched ceiling
  - frame for a suspended ceiling made of plasterboard, etc.
- Compatible with standard fastenings for suspended ceilings
- The FOLED system opens new possibilities of interior design

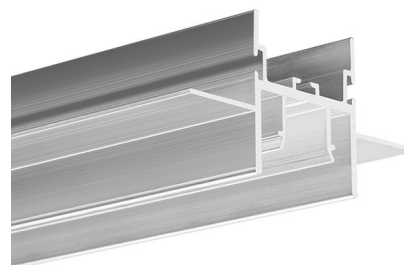

### FINISH :

Non anodized (raw) 

\*Custom colors available upon request

Fill empty fields

Product nr.

Fixture type

Company

Job name

Date

## TECHNICAL SPECIFICATION

### Application

- for building ceilings employing the stretch-film technology with integrated LED lighting
- for building suspended ceilings with plasterboard
- the extrusion has a channel adapted to attach standard harpoons used in stretched surfaces

### Assembly

- with the "FOLHAK" connectors and suspended ceiling hangers available on the market

### Additional information

- intended for indoor and outdoor use
- profiles can be connected with each other at an angle over 60 degrees
- fixture is flush with the plane of the film
- easy connection using "ZM CONNECTORS"
- compatible with the whole FOLED profile family
- spece for LED strip: 13.2 mm

## AVAILABLE LENGTHS

Ref. nr.	surface finish	available lengths
B8332V1NA_1	Non anodized (raw)	1000 mm
B8332V1NA_2	Non anodized (raw)	2000 mm
B8332V1NA_3	Non anodized (raw)	3000 mm

**TECHNICAL DRAWING**

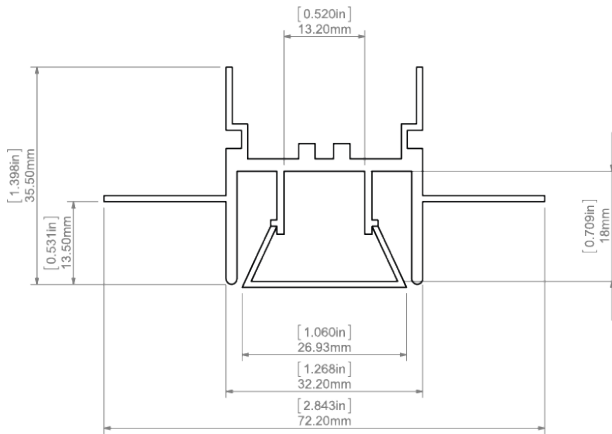

**RELATED PROFILES**

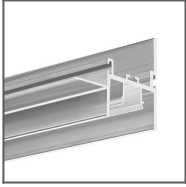

FOLED-BOK  
profile  
Ref: B8334V1

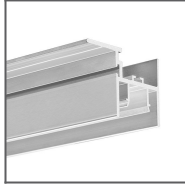

FOLED-SUF Profile  
Ref: B8333V1

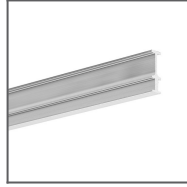

FOLHAK Profile  
Ref: B8338

**RELATED PRODUCTS**

**COVERS**

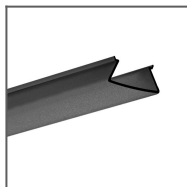

FOLED black Cover  
Ref: 17045

80°

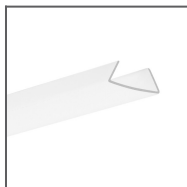

FOLED frosted Cover  
Ref: 17077V1

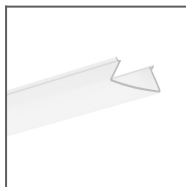

FOLED frosted Cover  
Ref: 17047

100°



**END CAPS**



FOLED-W black  
End cap  
Ref: 24285

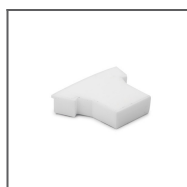

FOLED-W white  
End cap  
Ref: 24277

**ACCESSORIES**



6x1,2 Gland  
Ref: 00802

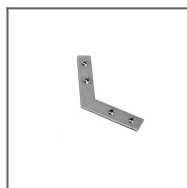

ZM-NA-120  
Connector  
Ref: 42729

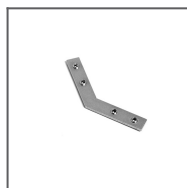

ZM-NA-135  
Connector  
Ref: 42725

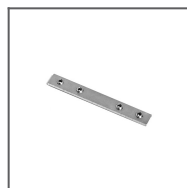

ZM-NA-180  
Connector  
Ref: 42724



ZM-NA-45  
Connector  
Ref: 42339

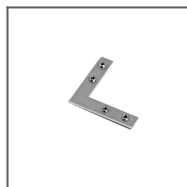

ZM-NA-90  
Connector  
Ref: 42723



ZM-NA-PION-120  
Connector  
Ref: 42321

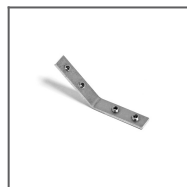

ZM-NA-PION-135  
Connector  
Ref: 42727



ZM-NA-PION-45  
Connector  
Ref: 42315

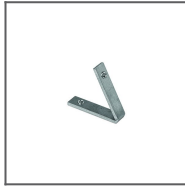

ZM-NA-PION-60  
Connector  
Ref: 42317

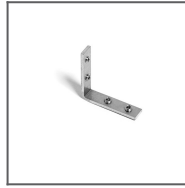

ZM-NA-PION-90  
Connector  
Ref: 42726

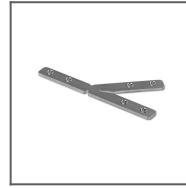

ZM-T45-G  
Connector  
Ref: 42324

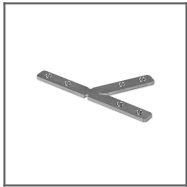

ZM-T60-G  
Connector  
Ref: 42326

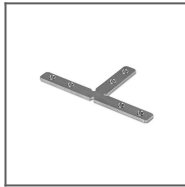

ZM-T90-G  
Connector  
Ref: 42328

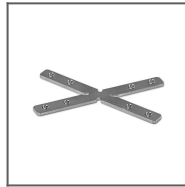

ZM-X60-G  
Connector  
Ref: 42332

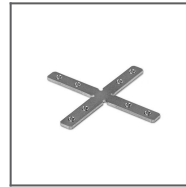

ZM-X90-G  
Connector  
Ref: 42334



ZM-Y120-G  
Connector  
Ref: 42336

## MARKETING MATERIALS



Display  
P230-90111M  
Ref: 90111M



Presentation set 7  
Ref: 90126