

## PRODUCT DESCRIPTION

- Designed to reach an IP67 waterproof rating
- Possible to obtain a line of light
- A wide range of available accessories
- Possible to bend the profile

### FINISH :

Silver anodized 

\*Custom colors available upon request



Fill empty fields

Product nr.

Fixture type

Company

Job name

Date

## TECHNICAL SPECIFICATION

### Application

- construction of lighting fixtures for main or decorative lighting

### Assembly

- suitable for mounting on flat surfaces, suspending from **DP** fasteners, for attaching to mounting systems and for fixing with mounting springs, to ARMSTRONG ceilings with the **AM-24** mounting bracket
- compatible with a group of profiles dedicated to drywall panels. It is designed for mounting in the **TEKNIK-ZM** and **TEKUS** profiles using **TEKNIK** latches

Number of latches:

Profile length	1 m	2 m	3 m
Number of TEKNIK latches	8	18	28

### Additional information

- possibility of making a linear fixture with IP67 protection, which means the fixture is dustproof and waterproof
- achieving IP67 is possible with the following covers: LIGER-22, MUN-22 and HS-22
- can be mounted in a groove made using a mounting extrusion
- a line of light obtainable with the **LIGER-22** cover and a LED strip with a minimum of 120 LEDs/meter
- GIZA-LL is designed for two or one 10 mm wide LED strip

### Profile bending

Minimum internal radius	Minimum external radius
-------------------------	-------------------------

250 mm	350 mm
--------	--------

- minimum radius - bending radius which when exceeded causes destruction (deformation, bending or lack of compatibility with other accessories, e.g. covers, end caps, etc.) of the profile
- internal radius - refers to the profile bent so that the cover is facing the inside of the arch
- external radius - refers to the profile bent so that the cover is facing the outside of the arch
- irregular curves are possible after consultation and individual quotation
- when bending anodized profiles, one should be aware of cracking of the anode coating (which may be more or less visible depending on the radius)

### AVAILABLE LENGTHS

Ref. nr.	surface finish	available lengths
C0758ANODA_1	Silver anodized	1000 mm
C0758ANODA_2	Silver anodized	2000 mm
C0758ANODA_3	Silver anodized	3000 mm

### TECHNICAL DRAWING

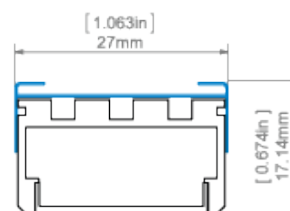
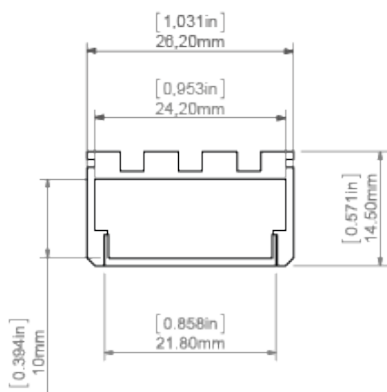

GIZA-LL profile and AM-24 mounting bracket  
profil GIZA-LL z mocownikiem AM-24

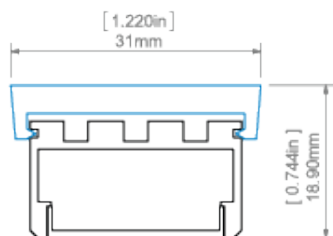

GIZA-LL profile and GIP mounting bracket  
profil GIZA-LL z mocownikiem GIP

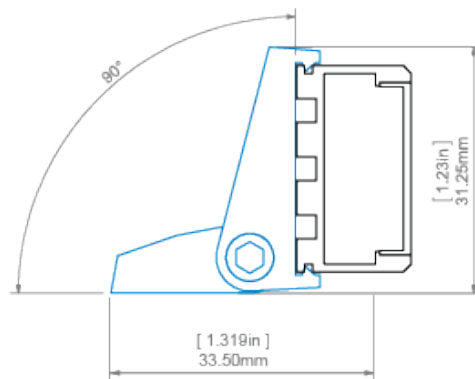

GIZA-LL profile and REGIP-UV mounting bracket  
profil GIZA-LL z mocownikiem REGIP-UV

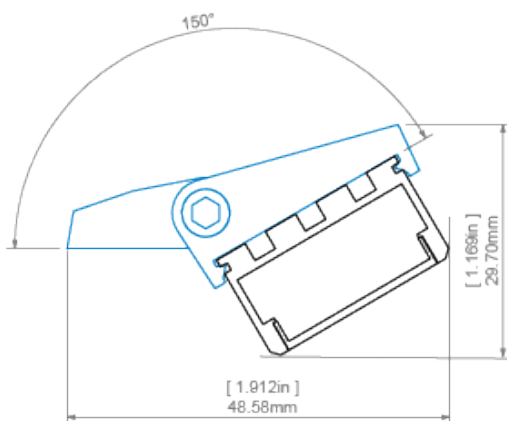

GIZA-LL profile and REGIP-UV mounting bracket  
profil GIZA-LL z mocownikiem REGIP-UV

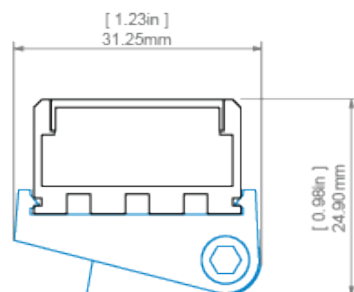

GIZA-LL profile and REGIP-UV mounting bracket  
profil GIZA-LL z mocownikiem REGIP-UV

**RELATED PROFILES**

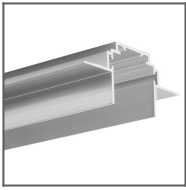

TEKNIK-ZM Profile  
Ref: C0399

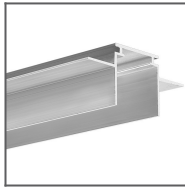

TEKUS Profile  
Ref: B6638V1

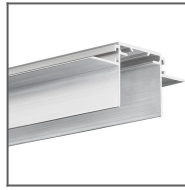

TEKUS-ZM Profile  
Ref: C1293

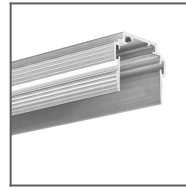

TEKNIK-ZM-TK  
Profile  
Ref: C1554

**RELATED PRODUCTS**

**COVERS**

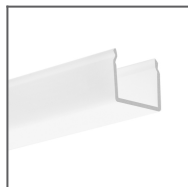

G-K frosted Cover  
Ref: 17007

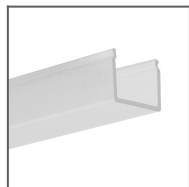

G-K semi-transparent Cover  
Ref: 00415



G-L clear Cover  
Ref: 17006

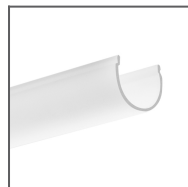

G-L frosted Cover  
Ref: 00413

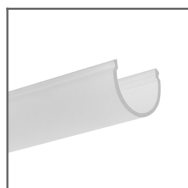

G-L semi-transparent Cover  
Ref: 17008

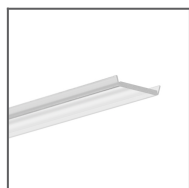

HS-22 clear Cover  
Ref: 17022

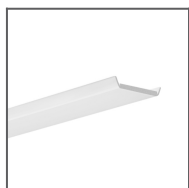

HS-22 frosted Cover  
Ref: 17011

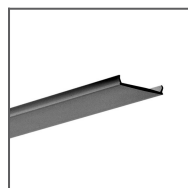

LIGER-22 black Cover  
Ref: 17044

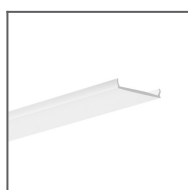

LIGER-22 frosted Cover  
Ref: 17032V1

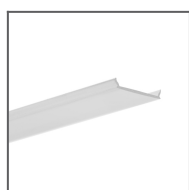

MUN-22 semi-transparent Cover  
Ref: 17042

110°



**END CAPS**



GIZA-LL grey End cap  
Ref: 24281

**ACCESSORIES**



BZP Head  
Ref: 42213



BZP-ZO Head  
Ref: 42214



BZP-ZZ Head  
Ref: 42215



DP Fastener  
Ref: 00644



DP-ZO Fastener  
Ref: 00649



DP-ZZ Fastener  
Ref: 00651



FI-10-ZM-P  
Fastener  
Ref: 42244



FI-10-ZM-W  
Fastener  
Ref: 42242

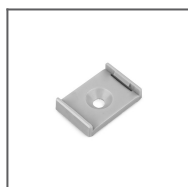

GIP Mounting  
bracket  
Ref: 24332



GIP-UV Mounting  
bracket  
Ref: 24310



 GIP-UV black  
Mounting bracket  
Ref: 24328

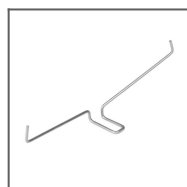

GP Spring  
Ref: 00293



Gland 6,4x3  
Ref: 42264



M11 Fastener set  
Ref: 42609



M12 Fastener set  
Ref: 42610

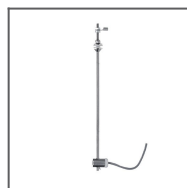

M13 Fastener set  
Ref: 42611

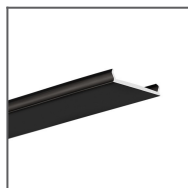

MP-22 Masking  
cover black  
Ref: 17167L9005

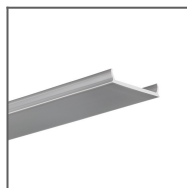

MP-22 metallized  
Masking cover  
Ref: 17167

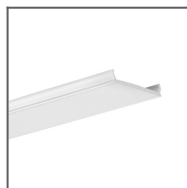

MP-22 white  
Masking cover  
Ref: 17167L9010



PUSZ-LIN-ZM  
Fastener  
Ref: 42256



PUSZ-LIN-ZM  
Fastener  
Ref: 42275



PUSZ-LIN-ZM  
black Fastener  
Ref: 42275L9005



PUSZ-PRET-ZM  
Fastener  
Ref: 42250



PUSZ-PRET-ZM  
Fastener  
Ref: 42276



PUSZ-PRET-ZM  
black Fastener  
Ref: 42276L9005



RD-1 Fastener set  
black  
Ref: 42650



RD-1 Fastener set  
silver  
Ref: 42649



REGIP-UV  
Mounting bracket  
Ref: 24271



RG-1 Fastener set  
black  
Ref: 42648



RG-1 Fastener set  
silver  
Ref: 42647

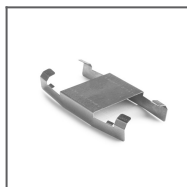

Soporte de  
montaje AM-24  
Ref: 24235



TEKNIK Latch  
Ref: 24003

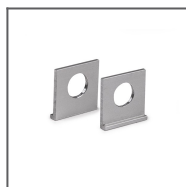

UCHO-ZM Hanger  
Ref: 42512

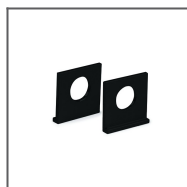

UCHO-ZM black  
Hanger  
Ref: 42525



W1 Fastener set  
Ref: 42602



W2 Fastener set  
Ref: 42603

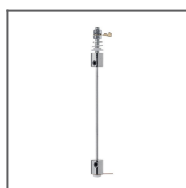

W6 Fastener set  
Ref: 42604



W7 Fastener set  
Ref: 42605

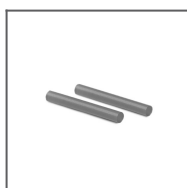

ZM Block  
Ref: 42520

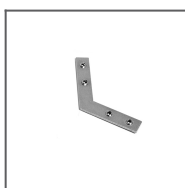

ZM-120  
Connector  
Ref: 42728

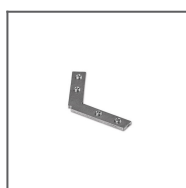

ZM-120-G  
Connector  
Ref: 42308

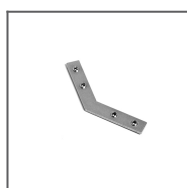

ZM-135  
Connector  
Ref: 42720

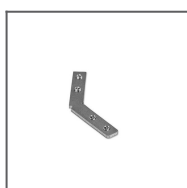

ZM-135-G  
Connector  
Ref: 42310

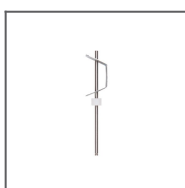

ZM-150 Fastener  
Ref: 42118

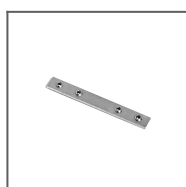

ZM-180  
Connector  
Ref: 42717

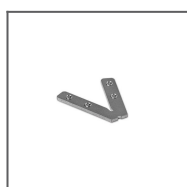

ZM-45-G  
Connector  
Ref: 42338

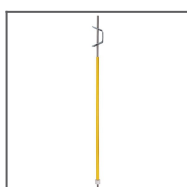

ZM-500 Fastener  
Ref: 42119

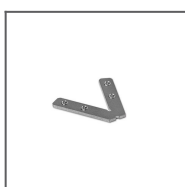

ZM-60-G  
Connector  
Ref: 42304

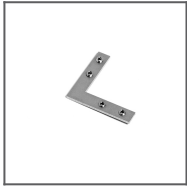

ZM-90 Connector  
Ref: 42716

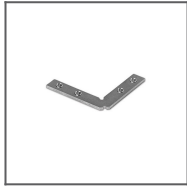

ZM-90-G  
Connector  
Ref: 42306

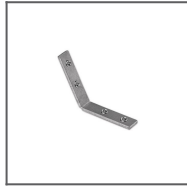

ZM-PION-120  
Connector  
Ref: 42320

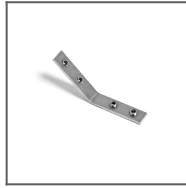

ZM-PION-135  
Connector  
Ref: 42719



ZM-PION-45  
Connector  
Ref: 42314



ZM-PION-90  
Connector  
Ref: 42718

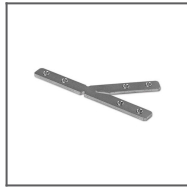

ZM-T45-G  
Connector  
Ref: 42324

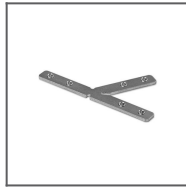

ZM-T60-G  
Connector  
Ref: 42326

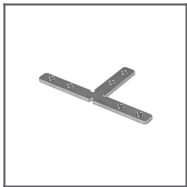

ZM-T90-G  
Connector  
Ref: 42328

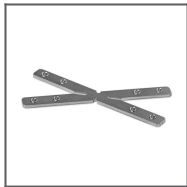

ZM-X45-G  
Connector  
Ref: 42330

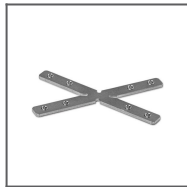

ZM-X60-G  
Connector  
Ref: 42332

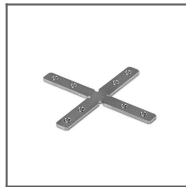

ZM-X90-G  
Connector  
Ref: 42334



ZM-Y120-G  
Connector  
Ref: 42336

## MARKETING MATERIALS



Display  
P230-90113M  
Ref: 90113M



Display  
P230-90156M  
Ref: 90156M



Foam 70263  
Ref: 70263



Foam 70266  
Ref: 70266