

PRODUCT DESCRIPTION

- A mounting channel flush with the surface of solid masonry walls and ceiling
- Place for routing power cables
- The TECH-28 protective insert can be used to protect the interior of the TEKNIK-ZM-TK channel against dirt during construction work
- Possibility to connect the TEKNIK-ZM-TK in long runs using ZM connectors

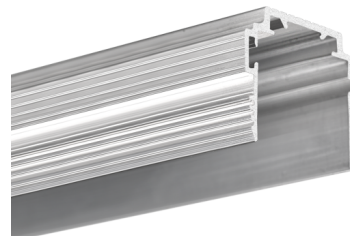

FINISH :

Non anodized (raw) 

*Custom colors available upon request

Fill empty fields

Product nr.	
Fixture type	
Company	
Job name	
Date	

TECHNICAL SPECIFICATION

Application

- for building precise mounting channels for linear LED lighting fixtures flush with the surface of a wall or ceiling, made in masonry or casting technologies

Assembly

- to be embedded in the surfaces of solid walls and ceilings, before plastering
- after applying the plaster, the edges of the TEKNIK-ZM-TK profile must be flush with the plane of the finished wall
- LED lighting fixtures are installed in the TEKNIK-ZM-TK profile with TEKNIK clips

Additional information

- TEKNIK-ZM-TK allows you to connect mounting channels into runs between the planes of walls made of different materials. For example, the mounting channel embedded in a solid masonry wall can be connected with a profile embedded in drywall (e.g. TEKNIK-ZM profile). The final effect is a line of light passing from the masonry load bearing wall to the partition wall made of drywall
- TEKNIK-ZM-TK is compatible with many profiles, e.g. LOKOM, GIZA, LIPOD, GIZA-LL
- if a profile with a height of less than 24mm is installed in TEKNIK-ZM-TK (e.g. GIZA-LL), paint the inner side walls of the TEKNIK-ZM-TK mounting channel the color of the ceiling or wall surface finish
- the TEKNIK-ZM-TK assembly channel has space at the bottom for cables and micro-connectors
- dimensions of the mounting groove in the masonry wall for the TEKNIK-ZM-TK profile: 40mm (width) x 35mm (depth)

AVAILABLE LENGTHS

Ref. nr.	surface finish	available lengths
C1554NA_1	Non anodized (raw)	1000 mm
C1554NA_2	Non anodized (raw)	2000 mm
C1554NA_3	Non anodized (raw)	3000 mm

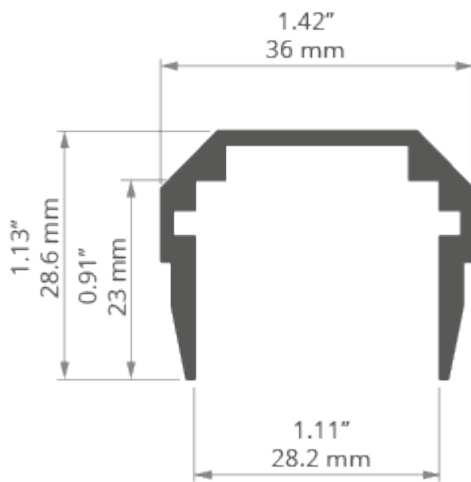
TECHNICAL DRAWING

RELATED PROFILES

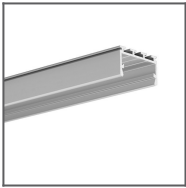

GIZA-LL profile
Ref: C0758

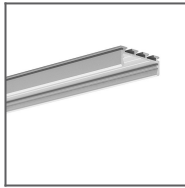

GIZA Profile
Ref: B5556

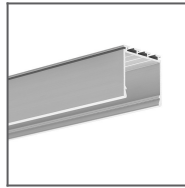

LIPOD Profile
Ref: B5554

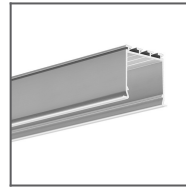

LOKOM Profile
Ref: B5553

RELATED PRODUCTS

END CAPS



TEKNIK-ZM grey
End cap
Ref: 24264

ACCESSORIES



8,8x1,2 Gland
Ref: 00802

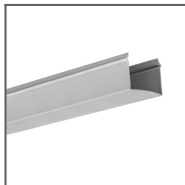

TECH-28
protective insert
Ref: 17168



TEKNIK Latch
Ref: 24003

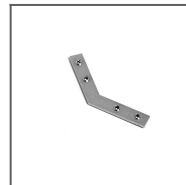

ZM-NA-135
Connector
Ref: 42725



ZM-NA-180
Connector
Ref: 42724

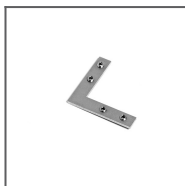

ZM-NA-90
Connector
Ref: 42723

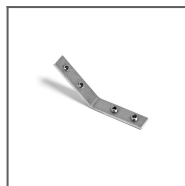

ZM-NA-PION-135
Connector
Ref: 42727

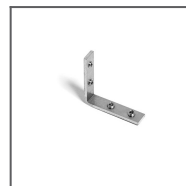

ZM-NA-PION-90
Connector
Ref: 42726