

## PRODUCT DESCRIPTION

- Very small size (fits in a slot 8 mm deep by 12 mm wide)
- Possibility to use the TECH-10 protective insert to protect the interior of the extrusion from contamination during construction work
- Clean installation of a LED strip
- Lighting fixtures can be combined into long runs using ZM connectors

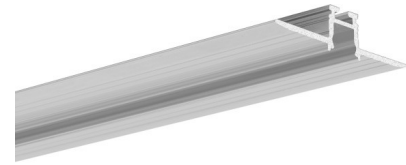

### FINISH :

Non anodized (raw) 

\*Custom colors available upon request

Fill empty fields

Product nr.

Fixture type

Company

Job name

Date

## TECHNICAL SPECIFICATION

### Application

- for constructing straight or sectioned LED lighting fixtures which are flush with the ceiling or wall
- for obtaining built-in "thin" lines of light

### Assembly

- the profile is mounted with a special drywall adhesive (CEKOL GS-20 gypsum adhesive or other with similar parameters)

### Additional information

- possibility to build fixtures going seamlessly from recessed to suspended (KOZEL-10 extrusions can be combined with [PIKO-ZM](#) profiles using [ZM connectors](#) for creating lighting runs that stretch into the open area of the room)
- the profile can be used with the [5-KLIK](#) LED strip (5KLIK - an LED strip sealed in a special silicone sleeve)
- ideal for applications in bathrooms and other rooms with high humidity
- spece for LED strip: 7.2 mm

## AVAILABLE LENGTHS

Ref. nr.	surface finish	available lengths
C1575NA_1	Non anodized (raw)	1000 mm
C1575NA_2	Non anodized (raw)	2000 mm
C1575NA_3	Non anodized (raw)	3000 mm

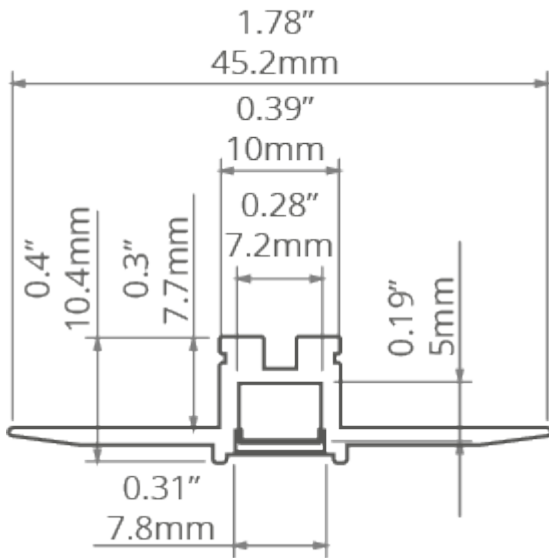
**TECHNICAL DRAWING**

**RELATED PRODUCTS**

**COVERS**

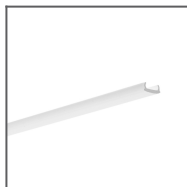

PIKO frosted  
Cover  
Ref: 17034

**END CAPS**

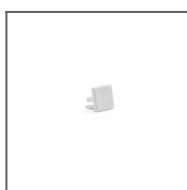

PIKO-ZM grey End  
cap  
Ref: 24307

**ACCESSORIES**

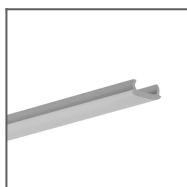

TECH-10  
protective insert  
Ref: 17126

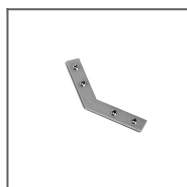

ZM-NA-135  
Connector  
Ref: 42725

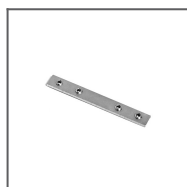

ZM-NA-180  
Connector  
Ref: 42724

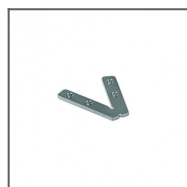

ZM-NA-45  
Connector  
Ref: 42339

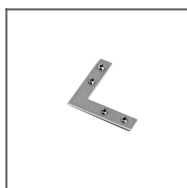

ZM-NA-90  
Connector  
Ref: 42723

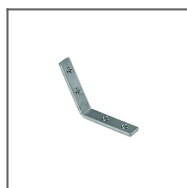

ZM-NA-PION-120  
Connector  
Ref: 42321

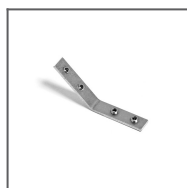

ZM-NA-PION-135  
Connector  
Ref: 42727



ZM-NA-PION-45  
Connector  
Ref: 42315

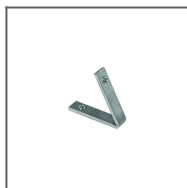

ZM-NA-PION-60  
Connector  
Ref: 42317

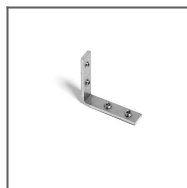

ZM-NA-PION-90  
Connector  
Ref: 42726

MARKETING MATERIALS



Display  
P230-90175M  
Ref: 90175M



Foam 70424  
Ref: 70424