

PRODUCT DESCRIPTION

- No need to shorten the covers to fit the end caps
- Minimum profile size for a 10 mm LED strip
- Modern design

FINISH :

Silver anodized Black anodized

*Custom colors available upon request



Fill empty fields

Product nr.	
Fixture type	
Company	
Job name	
Date	

TECHNICAL SPECIFICATION

Application

- for creating lighting fixtures recessed in furniture boards

Assembly

- with mounting adhesive

Additional information

- the extrusion will fit in 12 mm thick drywall.
- dimensions of the groove for recessing the profile: 18 mm x 7 mm (depth)
- spece for LED strip: 11.2 mm

AVAILABLE LENGTHS

Ref. nr.	surface finish	available lengths
C1587ANODA_1	Silver anodized	1000 mm
C1587ANODA_2	Silver anodized	2000 mm
C1587ANODA_2	Silver anodized	3000 mm
C1587K7_1	Black anodized	1000 mm
C1587K7_2	Black anodized	2000 mm

Ref. nr.	surface finish	available lengths
C1587K7_3	Black anodized	3000 mm

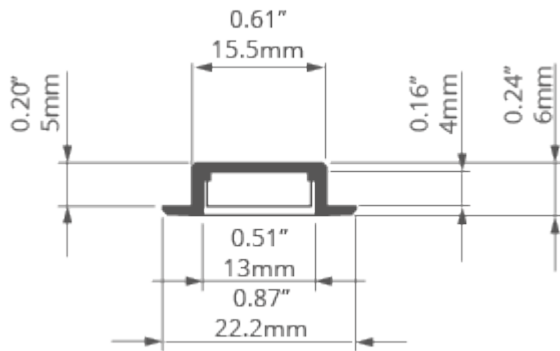
TECHNICAL DRAWING

RELATED PRODUCTS

COVERS

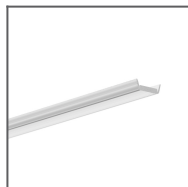

HS clear Cover
Ref: 1370



HS frosted Cover
Ref: 1369

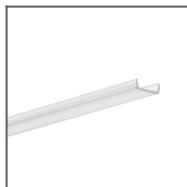

KA clear Cover
Ref: 17036

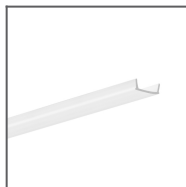

KA frosted Cover
Ref: 17035

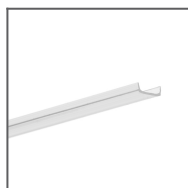

KA-COM clear
Cover
Ref: 17122

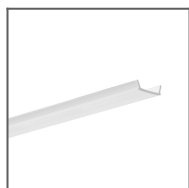

KA-COM frosted
Cover
Ref: 17121

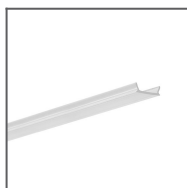

KA-PRO clear
Cover
Ref: 17065

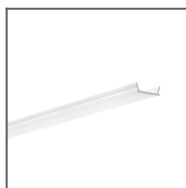

KA-PRO frosted
Cover
Ref: 17064

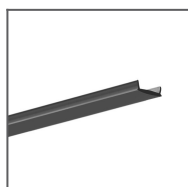

LIGER black Cover
Ref: 17040

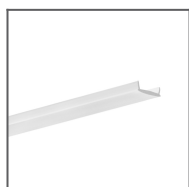

LIGER frosted
Cover
Ref: 17037

END CAPS

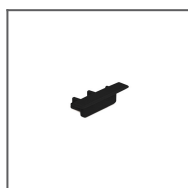

MICRO-NK black
End cap
Ref: 24362

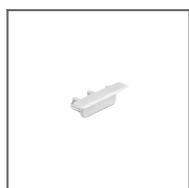

MICRO-NK grey
End cap
Ref: 24346

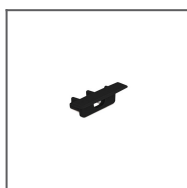

MICRO-NK-OTW
black End cap
Ref: 24363

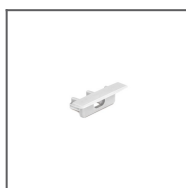

MICRO-NK-OTW
grey End cap
Ref: 24347

ACCESSORIES



8,8x1,2 Gland
Ref: 00802