

PRODUCT DESCRIPTION

- Minimum dimensions for 14 mm strips
- Economical end cap made of PP
- Economical T-cover with a simplified design

FINISH :

Silver anodized

*Custom colors available upon request



Fill empty fields

Product nr.	
Fixture type	
Company	
Job name	
Date	

TECHNICAL SPECIFICATION

Application

- for the construction of economic lighting fixtures with basic parameters

Assembly

- with mounting brackets from KLUŚ

Additional information

- to obtain a fully illuminated cover (without shadows at the end caps), it is recommended to use LED strips with a maximum width of 10 mm

AVAILABLE LENGTHS

Ref. nr.	surface finish	available lengths
C1919ANODA_1	Silver anodized	1000 mm
C1919ANODA_2	Silver anodized	2000 mm

TECHNICAL DRAWING

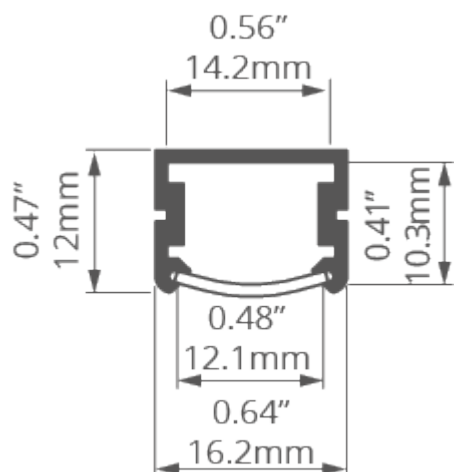

RELATED PRODUCTS

COVERS

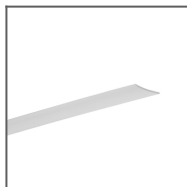

T semi-transparent Cover
Ref: 17004

END CAPS

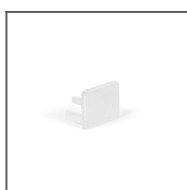

TAPO white End cap
Ref: 20055

ACCESSORIES



8,8x1,2 Gland
Ref: 00802



BZP Head
Ref: 42213



BZP-ZO Head
Ref: 42214



BZP-ZZ Head
Ref: 42215



DP Fastener
Ref: 00644



DP-MOC Fastener
Ref: 00645



DP-MOC-ZO Fastener
Ref: 00646

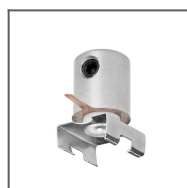

DP-MOC-ZZ Fastener
Ref: 00647



DP-ZO Fastener
Ref: 00649



DP-ZZ Fastener
Ref: 00651



M11 Fastener set
Ref: 42609



M12 Fastener set
Ref: 42610

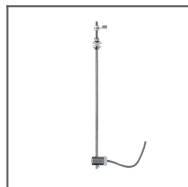

M13 Fastener set
Ref: 42611



M14 Fastener set
Ref: 42612



M3 Fastener set
Ref: 42303



M4 Fastener set
Ref: 42301



M5 Fastener set
Ref: 42302

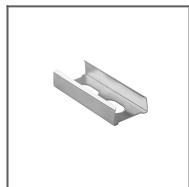

PD-MICRO
Connector
Ref: 42150

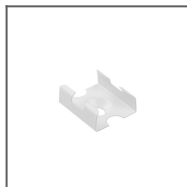

PDS Mounting
bracket
Ref: 24223



PDS Mounting
bracket
Ref: 24189

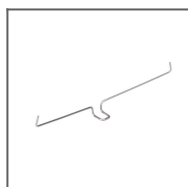

PDS Spring
Ref: 00800



PDS-STN
Mounting bracket
Ref: 24190



PUSZ-LIN-MR
Fastener
Ref: 42258



PUSZ-PRET-MR
Fastener
Ref: 42252



REG-PD-UV
Mounting bracket
Ref: 24270



ST Head
Ref: 42216



W10 Fastener set
Ref: 42608



W9 Fastener set
Ref: 42607



ZO Head
Ref: 42217



ZZ Head
Ref: 42218

MARKETING MATERIALS



Presentation set 6
Ref: 90125