

PRODUCT DESCRIPTION

- Bi-directional lighting
- Bendable without breaking the line of light
- Facilitates creation of geometric figures
- Large number of compatible accessories

FINISH :

Non anodized (raw) Silver anodized 

*Custom colors available upon request



Fill empty fields

Product nr.

Fixture type

Company

Job name

Date

TECHNICAL SPECIFICATION

Application

- decorative lighting.

Assembly

- suspended using dedicated accessories.

Additional information

- line of light obtainable with the LIGER-22 cover and a LED tape with at least 120 LEDs per meter,
- GIZA-DUO-LL profile is intended for two or one 10 mm wide LED tape (for one side of the profile),
- two tapes provide uniform illumination of the cover over its entire width (on one side of the profile),
- LED tape gluing width in the profile is 22 mm,
- cover and profile are equally long,
- broken line of light possible with the MP-22 masking cover,
- fixtures can be suspended and powered one under another,
- can be combined into closed figures using ZM-MINI-180 connectors,
- small locks on the sides of the profile.

Profile bending

Minimum radius for a bent
fixture

240 mm

AVAILABLE LENGTHS

Ref. nr.	surface finish	available lengths
C2162ANODA_1	Silver anodized	1000 mm
C2162ANODA_2	Silver anodized	2000 mm
C2162ANODA_3	Silver anodized	3000 mm
C2162NA_1	Non anodized (raw)	1000 mm
C2162NA_2	Non anodized (raw)	2000 mm
C2162NA_3	Non anodized (raw)	3000 mm

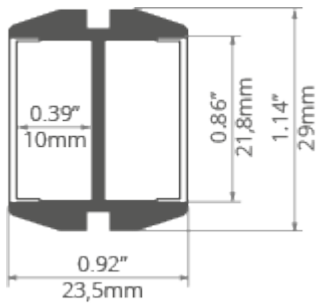
TECHNICAL DRAWING

RELATED PRODUCTS

COVERS

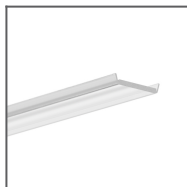

HS-22 clear Cover
Ref: 17022

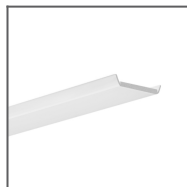

HS-22 frosted Cover
Ref: 17011

10°

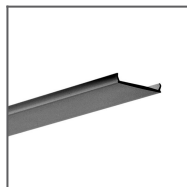

LIGER-22 black
Cover
Ref: 17044

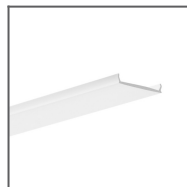

LIGER-22 frosted
Cover
Ref: 17032V1

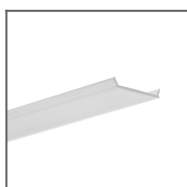

MUN-22 semi-
transparent Cover
Ref: 17042

END CAPS

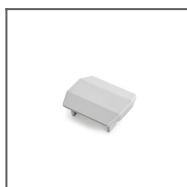

GIZA-DUO-LL grey
End cap
Ref: 24372

ACCESSORIES



BZP Head
Ref: 42213



BZP-ZO Head
Ref: 42214



BZP-ZZ Head
Ref: 42215



DP Fastener
Ref: 00644



DP-ZO Fastener
Ref: 00649



FI-10-ZM-P
Fastener
Ref: 42244



FI-10-ZM-W
Fastener
Ref: 42242



FI-8-LIN-ZM
Fastener black
Ref: 42285L9005



FI-8-LIN-ZM
Fastener silver
Ref: 42285



FI-8-LIN-ZMZ
Fastener black
Ref: 42286L9005



FI-8-LIN-ZMZ
Fastener silver
Ref: 42286



Gland 6,4x3
Ref: 42264

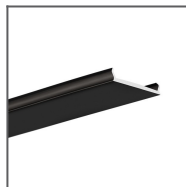

MP-22 Masking
cover black
Ref: 17167L9005

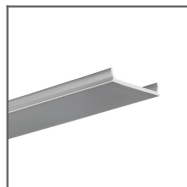

MP-22 metallized
Masking cover
Ref: 17167

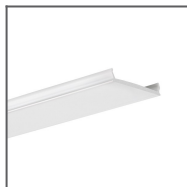

MP-22 white
Masking cover
Ref: 17167L9010



PUSZ-LIN-ZM
Fastener
Ref: 42275



PUSZ-LIN-ZM
black Fastener
Ref: 42275L9005



PUSZ-PRET-ZM
Fastener
Ref: 42276



PUSZ-PRET-ZM
black Fastener
Ref: 42276L9005



RD-1 Fastener set
black
Ref: 42649L9005



RD-1 Fastener set
silver
Ref: 42649NI



RG-1 Fastener set
black
Ref: 42647L9005



RG-1 Fastener set
silver
Ref: 42647NI

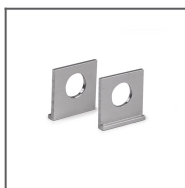

UCHO-ZM Hanger
Ref: 42512

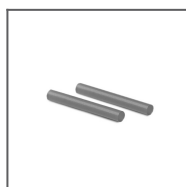

ZM Block
Ref: 42520

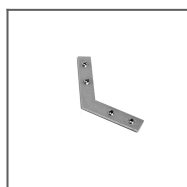

ZM-120
Connector
Ref: 42728

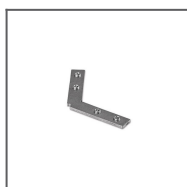

ZM-120-G
Connector
Ref: 42308

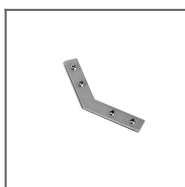

ZM-135
Connector
Ref: 42720



ZM-135-G
Connector
Ref: 42310

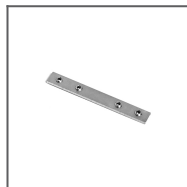

ZM-180
Connector
Ref: 42717

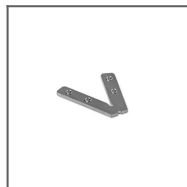

ZM-45-G
Connector
Ref: 42338

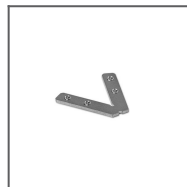

ZM-60-G
Connector
Ref: 42304

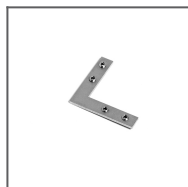

ZM-90 Connector
Ref: 42716

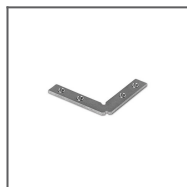

ZM-90-G
Connector
Ref: 42306



ZM-MINI-180
Connector
Ref: 44501



ZM-PION-120
Connector
Ref: 42320

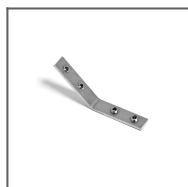

ZM-PION-135
Connector
Ref: 42719



ZM-PION-45
Connector
Ref: 42314

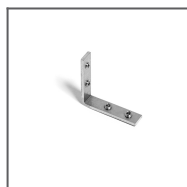

ZM-PION-90
Connector
Ref: 42718

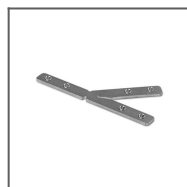

ZM-T45-G
Connector
Ref: 42324

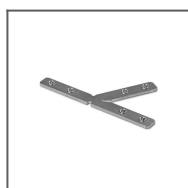

ZM-T60-G
Connector
Ref: 42326

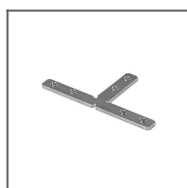

ZM-T90-G
Connector
Ref: 42328

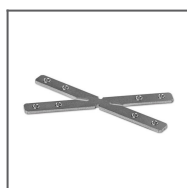

ZM-X45-G
Connector
Ref: 42330

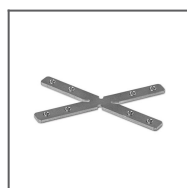

ZM-X60-G
Connector
Ref: 42332

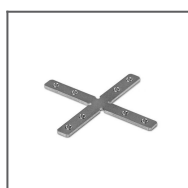

ZM-X90-G
Connector
Ref: 42334

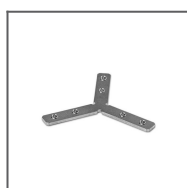

ZM-Y120-G
Connector
Ref: 42336