

PRODUCT DESCRIPTION

- Two lighting directions
- Smooth profile walls
- Installation through the cover hook

FINISH :

Silver anodized

*Custom colors available upon request

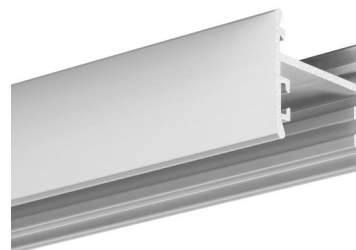

Fill empty fields

Product nr.

Fixture type

Company

Job name

Date

TECHNICAL SPECIFICATION

Application

- main and decorative lighting

Mounting

- suspended, using dedicated accessories
- can be easily connected into runs
- the cover is cut to the length of the profile

AVAILABLE LENGTHS

Ref. nr.	surface finish	available lengths
C3059ANODA_1	Silver anodized	1000 mm
C3059ANODA_2	Silver anodized	2000 mm
C3059ANODA_3	Silver anodized	3000 mm

TECHNICAL DRAWING

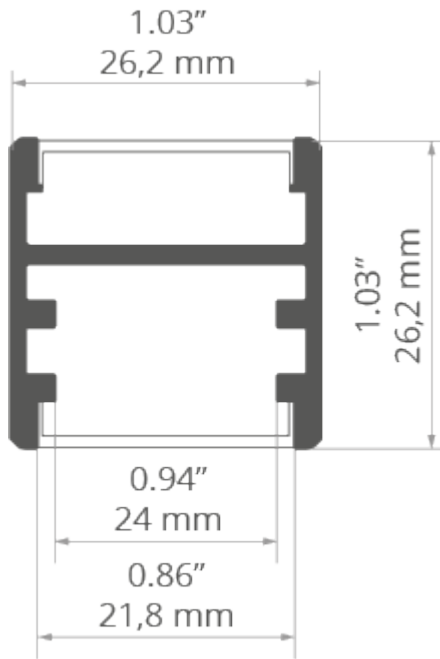

RELATED PRODUCTS

COVERS

BLACK COVERS



LIGER-22 black
Cover
Ref: 17087

CLEAR COVERS



HS-22 clear Cover
Ref: 17022

FROSTED COVERS



LIGER-22 frosted
Cover
Ref: 17032V1

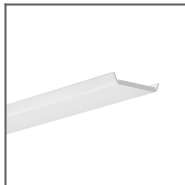

HS-22 frosted
Cover
Ref: 17011

SEMI-TRANSPARENT COVERS

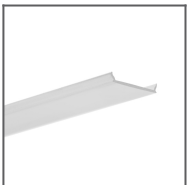

MUN-22 semi-
transparent Cover
Ref: 17042

END CAPS

REGULAR END CAPS

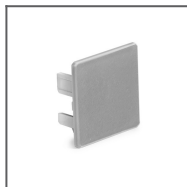

GLAZA-DUO
metalized End
cap
Ref: 24452



GLAZA-DUO grey
end cap
Ref: 24418

ACCESSORIES

FASTENERS & MOUNTING ACCESSORIES



OS22-LIN-Z
Fastener white
Ref: 42341L9010



OS22-PRET-Z
Fastener white
Ref: 42344L9010



OS22-DUO-LIN-Z
Fastener white
Ref: 42340L9010



OS22-DUO-PRET-Z
Fastener white
Ref: 42343L9010



OS22-LIN-Z
Fastener black
Ref: 42341L9005



OS22-PRET-Z
Fastener black
Ref: 42344L9005



OS22-DUO-LIN-Z
Fastener black
Ref: 42340L9005



OS22-DUO-PRET-Z
Fastener black
Ref: 42343L9005

COMPONENTS FOR CONNECTING PROFILES

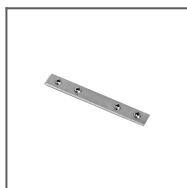

ZM-180
Connector
Ref: 42717

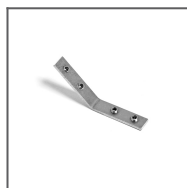

ZM-PION-135
Connector
Ref: 42719

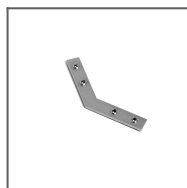

ZM-135
Connector
Ref: 42720

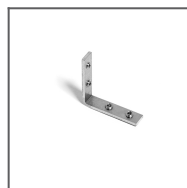

ZM-PION-90
Connector
Ref: 42718



ZM-90 Connector
Ref: 42716

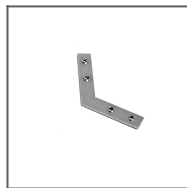

ZM-120
Connector
Ref: 42728

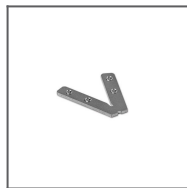

ZM-45-G
Connector
Ref: 42338

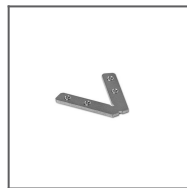

ZM-60-G
Connector
Ref: 42304

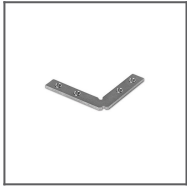

ZM-90-G
Connector
Ref: 42306



ZM-120-G
Connector
Ref: 42308

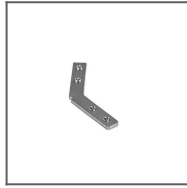

ZM-135-G
Connector
Ref: 42310



ZM-PION-45
Connector
Ref: 42314

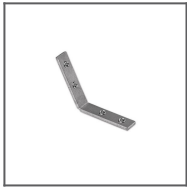

ZM-PION-120
Connector
Ref: 42320



ZM-MINI-180
Connector
Ref: 44501

SEALING COMPONENTS



6 x 1.2 Gland
Ref: 00802

ADDITIONAL ITEMS

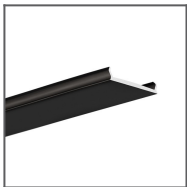

MP-22 Masking
cover black
Ref: 17167L9005



MP-22 metallized
Masking cover
Ref: 17167

LED TAPES

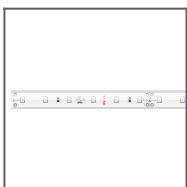

LED strip 8K-WP-
K-1210-24V
Ref: 8K-WP-
K-1210-24V

WHITE

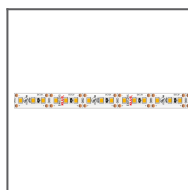

LED strip
K-1220-12V
Ref: K-1220-12V

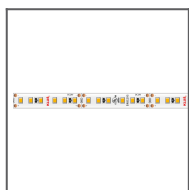

LED strip K-1220-24V
Ref: K-1220-24V

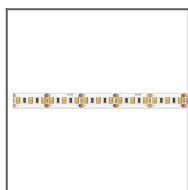

LED strip
K-1275-12V
Ref: K-1275-12V

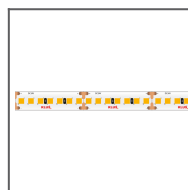

LED strip K-1820-
HD-24V
Ref: K-1820-HD-24V

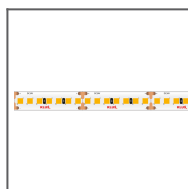

LED strip K-1910-
HD-24V
Ref: K-1910-HD-24V

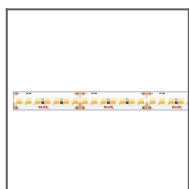

LED strip WP-K-1640-
HD-IP65-24V
Ref: WP-K-1640-HD-
IP65-24V

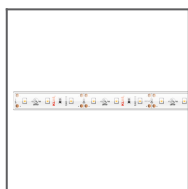

LED strip WP-
K-1210-12V
Ref: WP-
K-1210-12V



LED strip WP-
K-1210-24V
Ref: WP-K-1210-24V

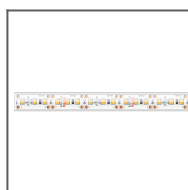

Taśma LED WP-
K-1220-12V
Ref: WP-K-1220-12V

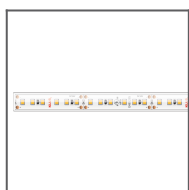

LED strip LED WP-
K-1220-24V
Ref: WP-K-1220-24V



LED strip WP-
K-1275-24V
Ref: WP-
K-1275-24V



Taśma LED WP-K-1910-
HD-IP65-24V
Ref: WP-K-1910-HD-
IP65-24V



LED strip WP-
K-1220-IP65-12V
Ref: WP-K-1220-
IP65-12V

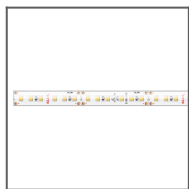

LED strip WP-K-1220-
IP65-24V
Ref: WP-K-1220-
IP65-24V

CRI 95+



LED strip WP-K-
CR-1210-24V
Ref: WP-K-
CR-1210-24V

LONG RUN

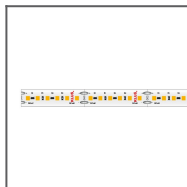

LED strip K-
LR-1000-24V
Ref: K-
LR-1000-24V

RGB / RGB-W

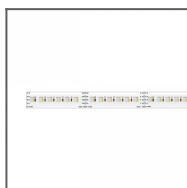

LED strip K-1530-
RGB+W-24V
Ref: K-1530-
RGB+W-24V

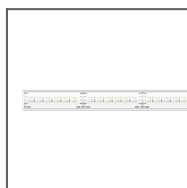

LED strip WP-K-1530-
RGB+W-24V
Ref: WP-K-1530-
RGB+W-24V

TUNABLE WHITE / DIM TO WARM

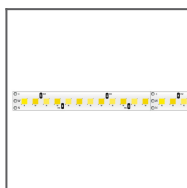

LED strip
K-22/50-1728-24V
Ref:
K-22/50-1728-24V

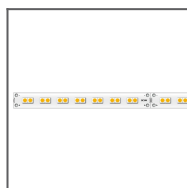

LED strip
K-30/18-1770-24V
Ref:
K-30/18-1770-24V

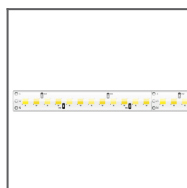

LED strip WP-
K-22/50-1728-24V
Ref: WP-
K-22/50-1728-24V

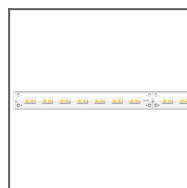

LED strip WP-
K-30/18-1770-24V
Ref: WP-
K-3018-1770-24V