

PRODUCT DESCRIPTION

- Installation of lighting and stretch films to ceilings
- High lumen output
- Line of light flush with the surface

FINISH :

Non anodized (raw) 

*Custom colors available upon request

Fill empty fields

Product nr.

Fixture type

Company

Job name

Date

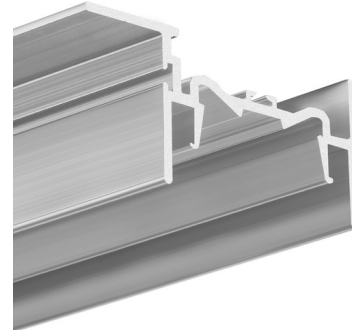

TECHNICAL SPECIFICATION

Application

- lighting recessed in surfaces made of stretch film

Mounting

- to the surface, using properly selected screws
- can be easily connected into runs
- the cover is cut to the length of the profile

Additional information

- the profile has grooves for the attachment of the hooks from the stretch film

AVAILABLE LENGTHS

Ref. nr.	surface finish	available lengths
C3631NA_1	Non anodized (raw)	1000 mm
C3631NA_2	Non anodized (raw)	2000 mm
C3631NA_3	Non anodized (raw)	3000 mm

TECHNICAL DRAWING

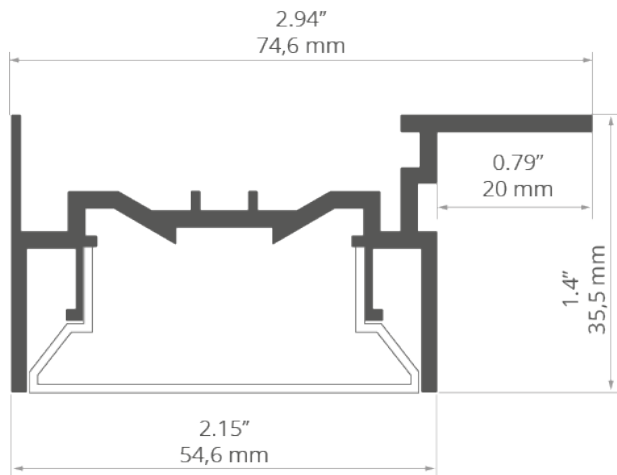

RELATED PROFILES

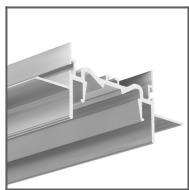

FOLED-50 Profile
Ref: C3632

RELATED PRODUCTS

COVERS

FROSTED COVERS

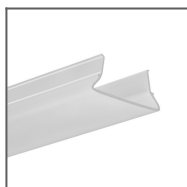

FOLED-50 frosted
Cover
Ref: 17171

END CAPS

REGULAR END CAPS



FOLED-50-W End
cap
Ref: 24294

ACCESSORIES

COMPONENTS FOR CONNECTING PROFILES

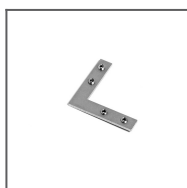

ZM-NA-90
Connector
Ref: 42723

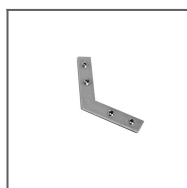

ZM-NA-120
Connector
Ref: 42729

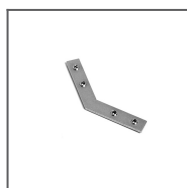

ZM-NA-135
Connector
Ref: 42725

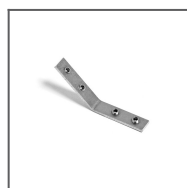

ZM-NA-PION-135
Connector
Ref: 42727

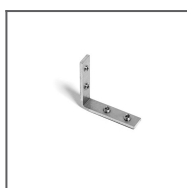

ZM-NA-PION-90
Connector
Ref: 42726

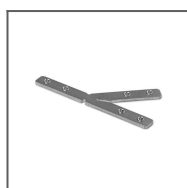

ZM-T45-G
Connector
Ref: 42324

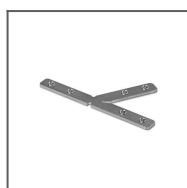

ZM-T60-G
Connector
Ref: 42326

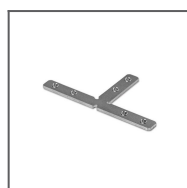

ZM-T90-G
Connector
Ref: 42328

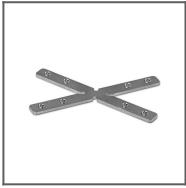

ZM-X60-G
Connector
Ref: 42332

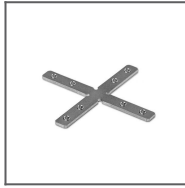

ZM-X90-G
Connector
Ref: 42334



ZM-Y120-G
Connector
Ref: 42336

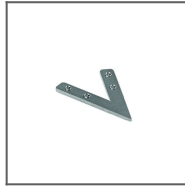

ZM-NA-45
Connector
Ref: 42339



ZM-NA-PION-120
Connector
Ref: 42321

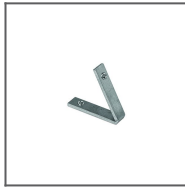

ZM-NA-PION-60
Connector
Ref: 42317

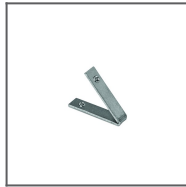

ZM-NA-PION-45
Connector
Ref: 42315

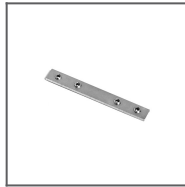

ZM-NA-180
Connector
Ref: 42724

SEALING COMPONENTS



6 x 1.2 Gland
Ref: 00802