

PRODUCT DESCRIPTION

- ADJUSTABLE ANGLE BETWEEN PROFILES
- Possibility of building lighting fixtures with polygonal shapes
- Well stabilized profile connections

Fill empty fields

Product nr.

Fixture type

Company

Job name

Date



TECHNICAL SPECIFICATION

Application

The product is used to create X45 fittings from anodized profiles equipped with at least one ZM socket in the bottom of the profile. In addition, it allows you to correct the angle between profiles in the range of +/- 5 degrees.

Assembly

With pressure screws.

Additional information

If the angle between the connected lighting fixtures is other than nominal, it can be bent to the desired value by 5 degrees on each side.

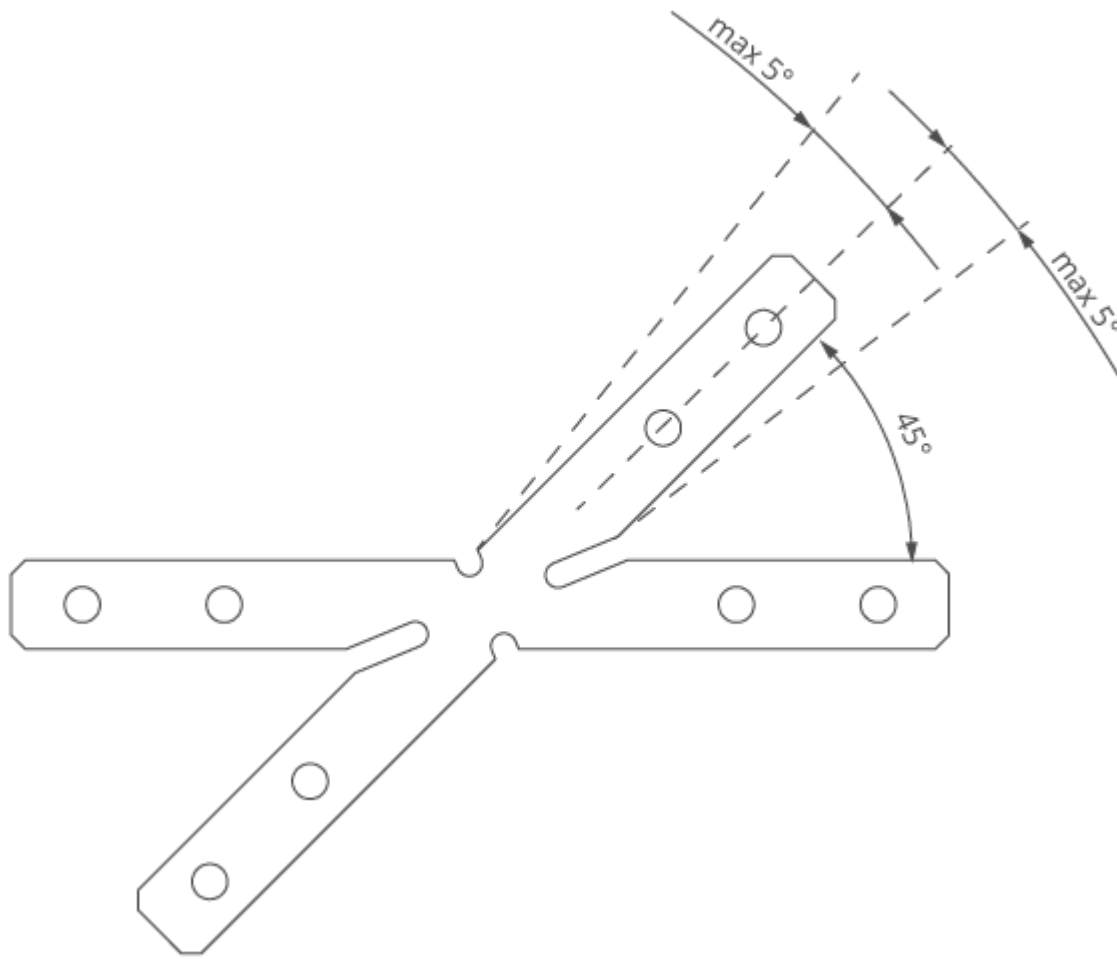

RELATED PROFILES

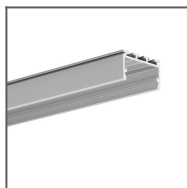

GIZA-LL profile
Ref: C0758

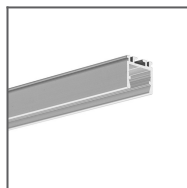

OPK-4 Profile
Ref: C0370

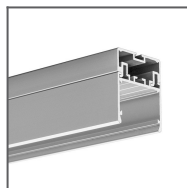

3035 Profile
Ref: 18039



JAZ Profile
Ref: B8547

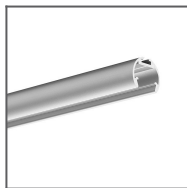

OLEK Profile
Ref: B8505

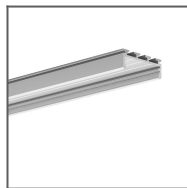

GIZA Profile
Ref: B5556

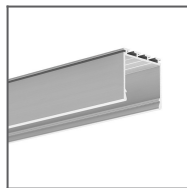

LIPOD Profile
Ref: B5554

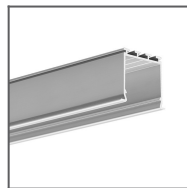

LOKOM Profile
Ref: B5553

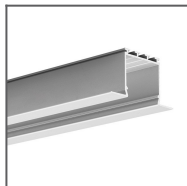

LARKO Profile
Ref: B5552

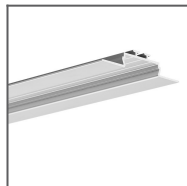

OPAC-30 Profile
Ref: B6164

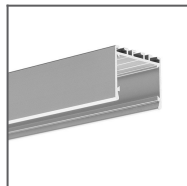

3035-O Profile
Ref: B8441

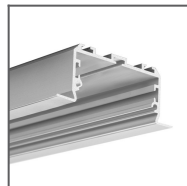

LARKO-50 Profile
Ref: C0756

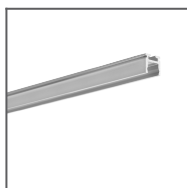

PIKO-ZM Profile
Ref: C1168

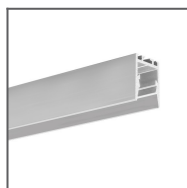

PDS-ZMG Profile
Ref: C1418

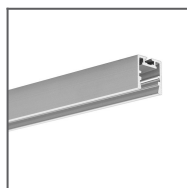

PDS-ZM-PLUS
Profile
Ref: C2056

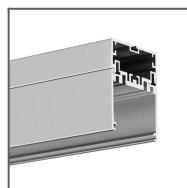

4050 Profile
Ref: 18050

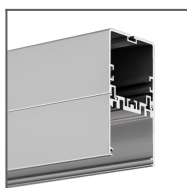

4050-W Profile
Ref: 18051