

## PRODUCT DESCRIPTION

- ADJUSTABLE ANGLE BETWEEN PROFILES
- Possibility of building lighting fixtures with polygonal shapes
- Well stabilized profile connections

Fill empty fields

Product nr.

Fixture type

Company

Job name

Date



## TECHNICAL SPECIFICATION

### Application

The product is used to create X90 fittings from anodized profiles equipped with at least one ZM socket in the bottom of the profile. In addition, it allows you to correct the angle between profiles in the range of +/- 5 degrees.

### Assembly

With pressure screws.

### Additional information

If the angle between the connected lighting fixtures is other than nominal, it can be bent to the desired value by 5 degrees on each side.

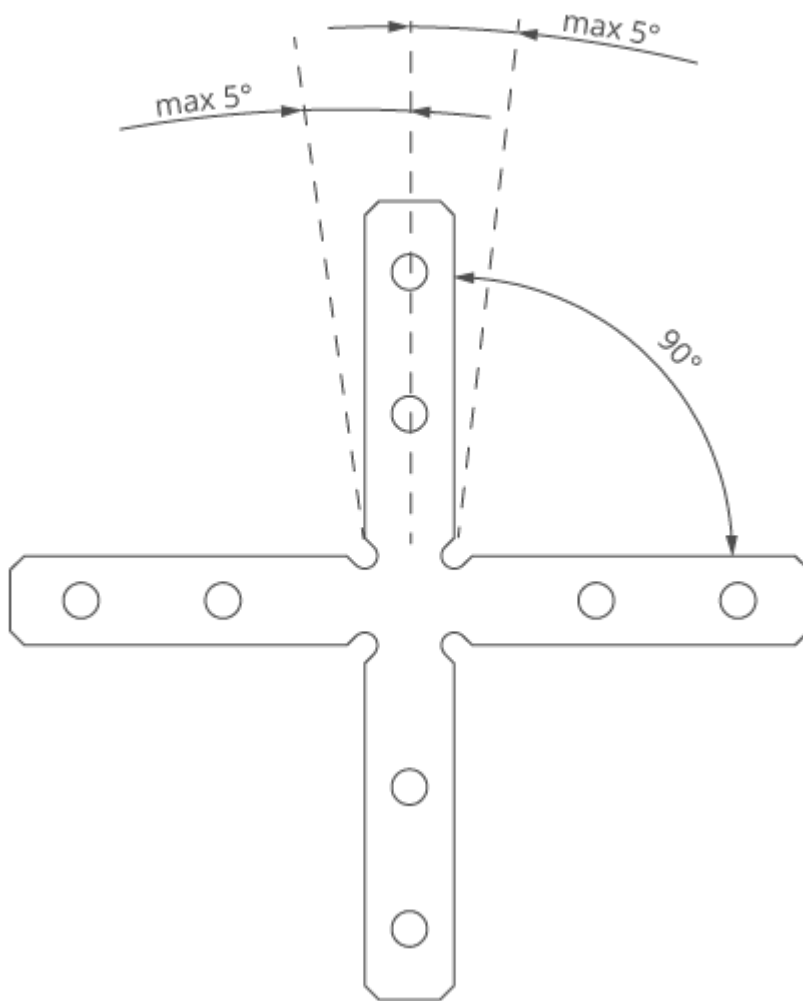

**RELATED PROFILES**

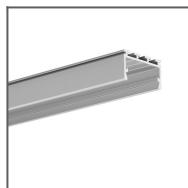

GIZA-LL profile  
Ref: C0758

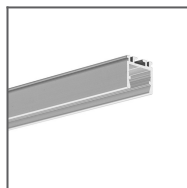

OPK-4 Profile  
Ref: C0370

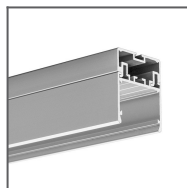

3035 Profile  
Ref: 18039



JAZ Profile  
Ref: B8547

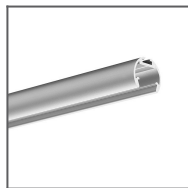

OLEK Profile  
Ref: B8505

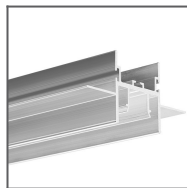

FOLED Profile  
Ref: B8332V1

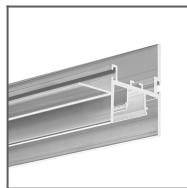

FOLED-BOK  
profile  
Ref: B8334V1

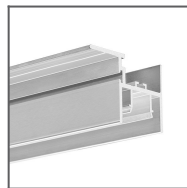

FOLED-SUF Profile  
Ref: B8333V1

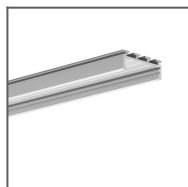

GIZA Profile  
Ref: B5556

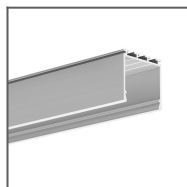

LIPOD Profile  
Ref: B5554

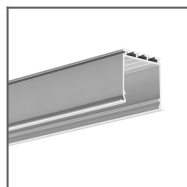

LOKOM Profile  
Ref: B5553

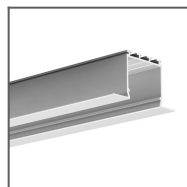

LARKO Profile  
Ref: B5552

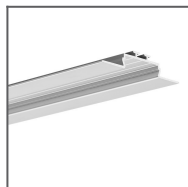

OPAC-30 Profile  
Ref: B6164

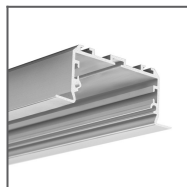

LARKO-50 Profile  
Ref: C0756

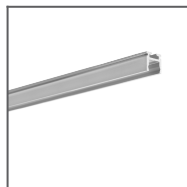

PIKO-ZM Profile  
Ref: C1168

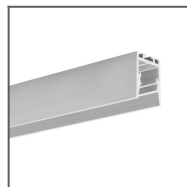

PDS-ZMG Profile  
Ref: C1418

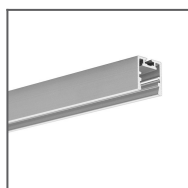

PDS-ZM-PLUS  
Profile  
Ref: C2056

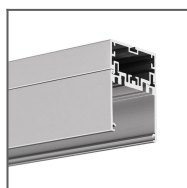

4050 Profile  
Ref: 18050

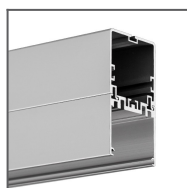

4050-W Profile  
Ref: 18051